

Pos	Part name	Material
1	Body	GG25 / EN- GJL- 250
2	Guide	GGG40 / EN- GJS- 400-15
3	Closing system	GGG40 / EN- GJS- 400-15
4	Seal	EPDM
5	Spring	AISI 302

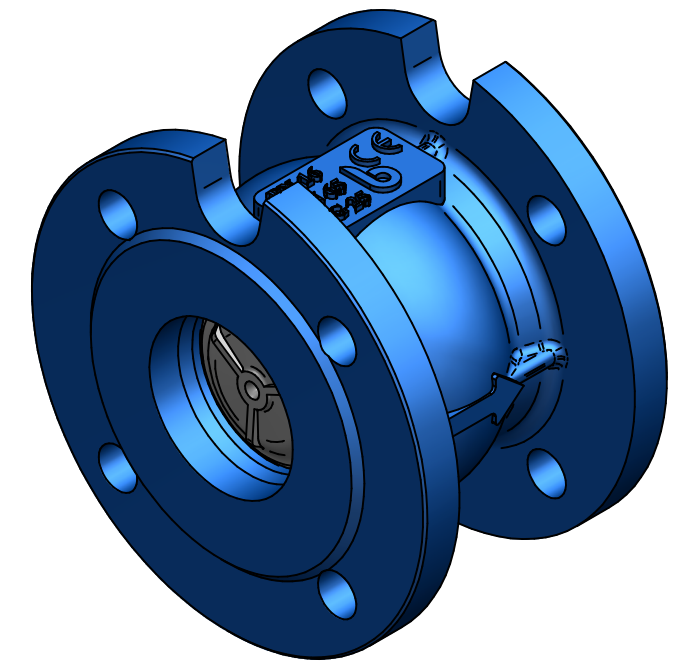
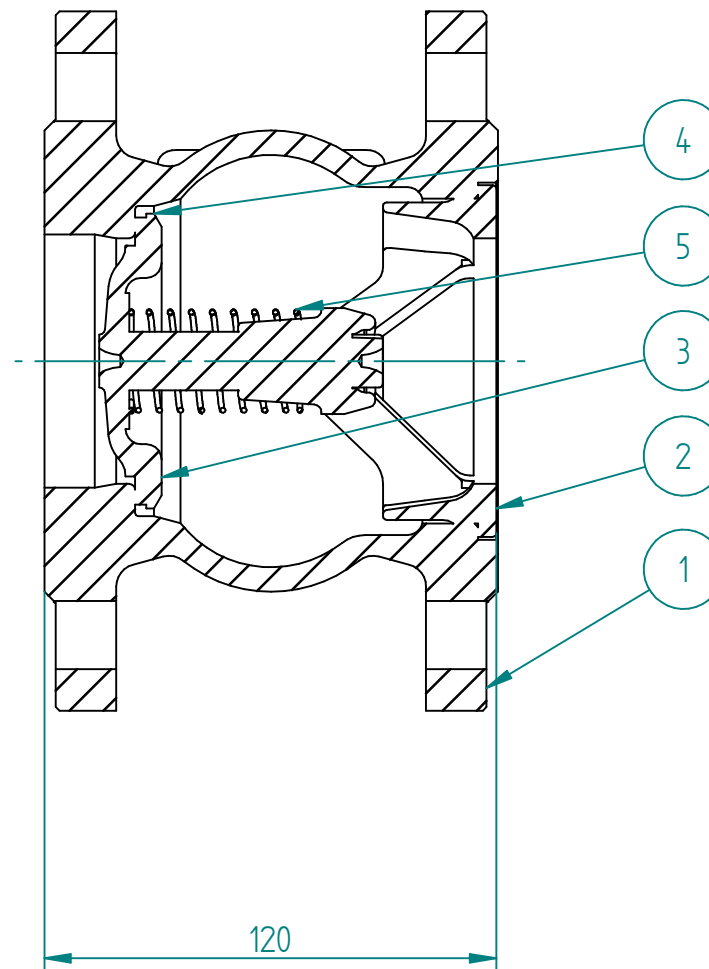
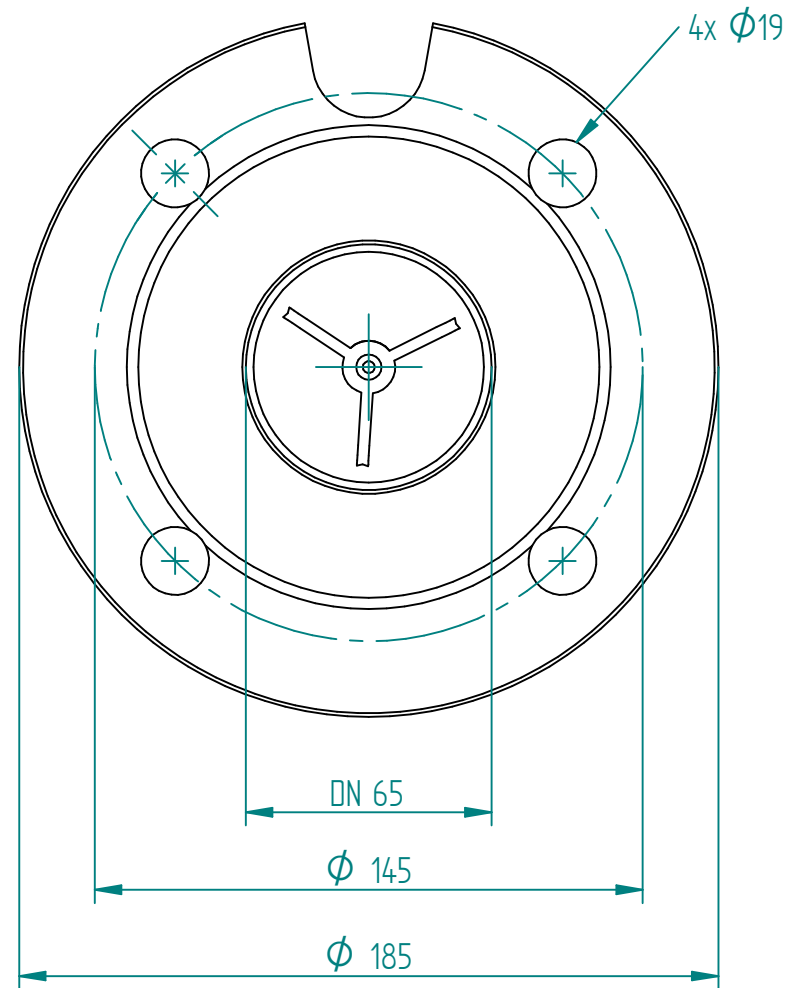

DRAWN	NAME	DATE	SIZE	DWG NO
	EMLA	20.12.2023	A3	ZET-180-402-52C-0065
CHECKED	EMLA	20.12.2023	FILE NAME: ZET-180-402-52C-0065.dft	
ENG APPR	TOCO	dd.mm.yyyy	SCALE: 1:2	REV: 00
MGR APPR	TOCO	dd.mm.yyyy	WEIGHT: 8,7 kg	SHEET: 1 OF 1

UNLESS OTHERWISE SPECIFIED DIMENSIONS ARE IN MILLIMETERS AND TOLERANCES ARE +/-0,5

REV	DESCRIPTION	DATE	APPROVED
00	ISSUED	21.12.23	RAGA
REVISION HISTORY			

TITLE CHECK VALVE FIG.402 DN65 PN16, GG25, GGG40/EPDM L-120MM, EPOXY COATED