

SECTION A-A

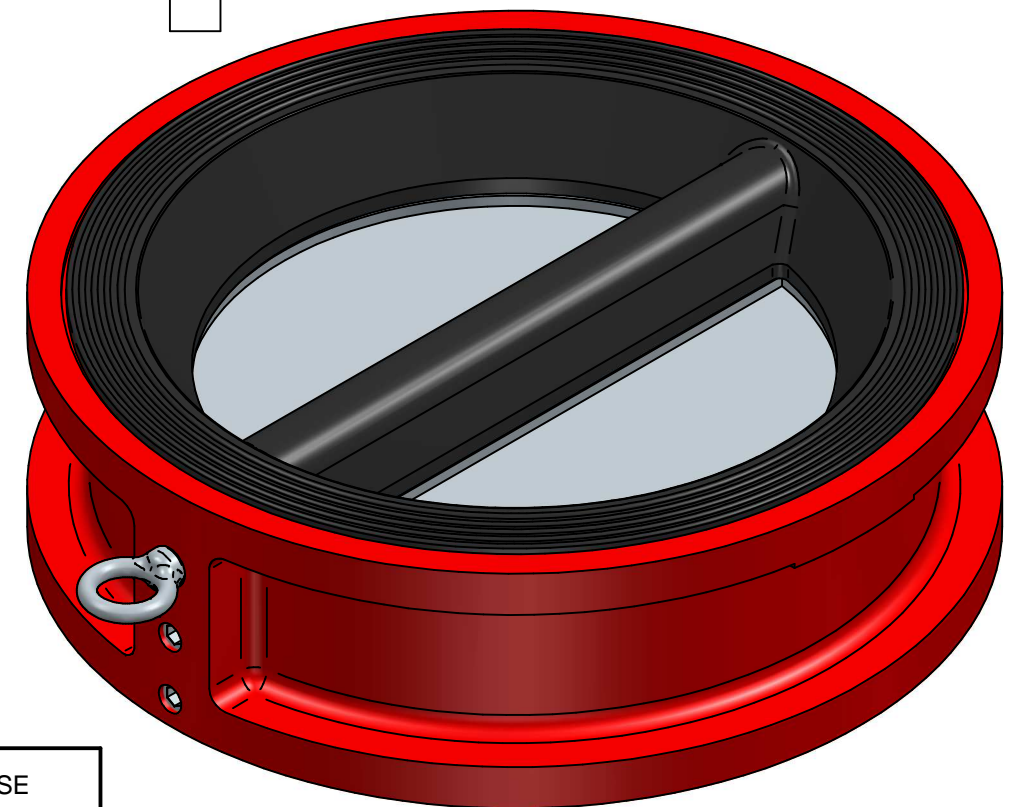

TITLE RUBBER COATED DUAL CHECK VALVE DN300, DI BODY, SS316 DISC, STAINLESS STEEL 316 SHAFT, EPDM		NAME	DATE	SIZE	DWG NO
	DRAWN	MOTO	28.08.2017	A3	QIF-180-022-300
	CHECKED	TOCO	28.08.2017	FILE NAME: QIF-180-022-0300.dft	
	ENG APPR	TOCO	28.08.2017	SCALE: 1:3	REV:
	MGR APPR	TOCO	28.08.2017	WEIGHT:	SHEET: 1 OF 2

UNLESS OTHERWISE SPECIFIED DIMENSIONS ARE IN MILLIMETERS AND TOLERANCES ARE +/-0,5

REV	DESCRIPTION	DATE	APPROVED
REVISION HISTORY			