

SECTION A-A

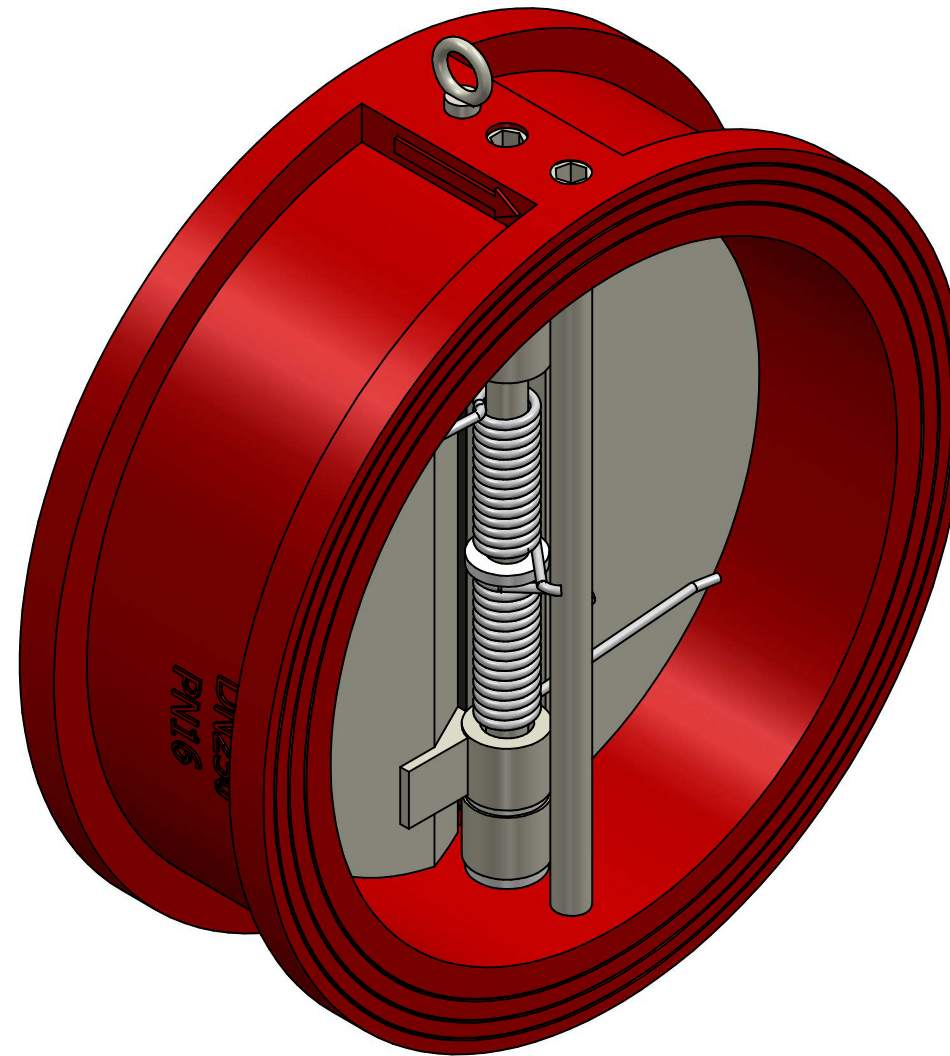
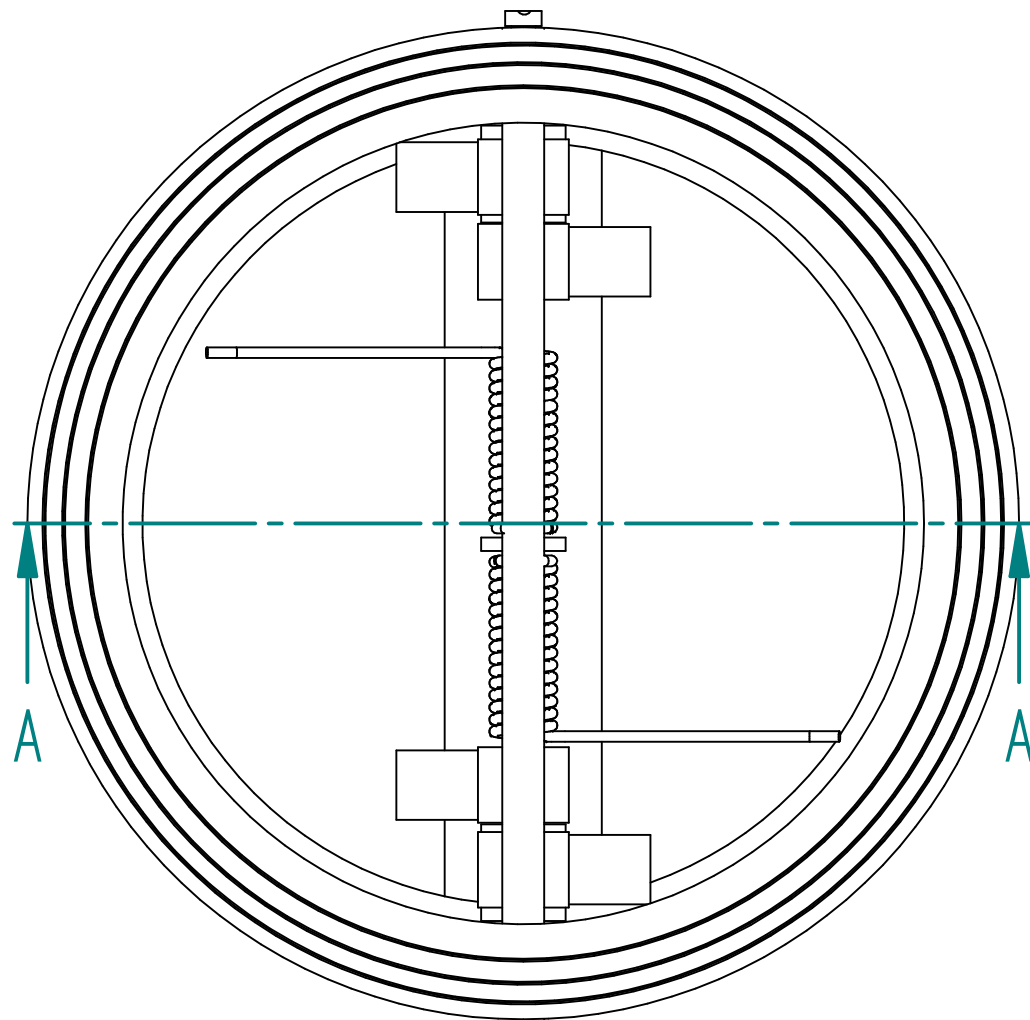

No.	Part Name	Material	Qty.
1	Body	DI	1
2	Seat	EPDM	1
3	Disc	Al.Br.	2
4	Spring	SS316	2
5	Stem	SS316	2

NOTE:

1. FACE TO FACE ISO5752
2. JOINT FLANGE BS4504 PN10/PN16
3. TEST API598

TECHNICAL DATA		
NOMINAL DIAMETER	DN500-DN800	DN50-DN450
NOMINAL PRESSURE	1.0 MPa	1.6 MPa
TESTING PRESSURE (SEALING)	1.1 MPa	1.76 MPa
TESTING PRESSURE (SHELL)	1.5 MPa	2.4 MPa



TITLE DUAL PLATE CHECK VALVE  
DN250 / PN10

	NAME	DATE	SIZE	DWG NO
DRAWN	MOTO	30.04.2018	A3	QIF-180-001-0250
CHECKED	TOCO	30.04.2018	FILE NAME: QIF-180-001-0250 QIF-180-002-0250.dft	
ENG APPR	TOCO	30.04.2018	SCALE: 1:2,5	REV: .....
MGR APPR	TOCO	30.04.2018	WEIGHT:	SHEET: 1 OF 2

UNLESS OTHERWISE SPECIFIED  
DIMENSIONS ARE IN MILLIMETERS  
AND TOLERANCES ARE +/-0,5

REV	DESCRIPTION	DATE	APPROVED
REVISION HISTORY			