

SECTION A-A

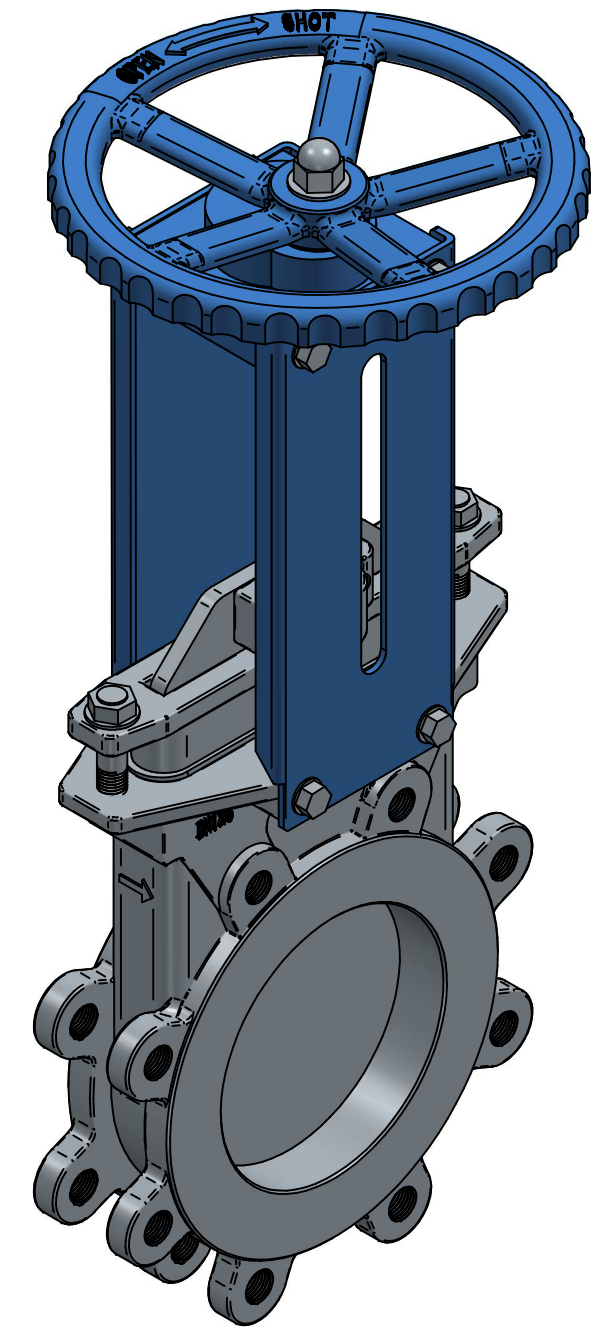

TITLE DN125 PN10 SS316 KNIFE GATE VALVE UNI-DIRECTION SS316 BODY, KNIFE AND STEM, EPOXY STEEL SUPPORTER VITON SEAT, HANDWHEEL, NON RISING STEM		NAME	DATE	SIZE	DWG NO
	DRAWN	MOTO	27.07.2020	A3	
	CHECKED	RESO	06.11.2020	FILE NAME: QIF-170-V03-0125.dft	
	ENG APPR	TOCO	dd.mm.yyyy	SCALE: 1:2	REV:
	MGR APPR	TOCO	dd.mm.yyyy	WEIGHT:	SHEET: 1 OF 1

UNLESS OTHERWISE SPECIFIED DIMENSIONS ARE IN MILLIMETERS AND TOLERANCES ARE +/-0,5

REV	DESCRIPTION	DATE	APPROVED
REVISION HISTORY			