

NO.	Part Name	Material
1	BODY	A216 WCB
2	BONNET	A216 WCB
3	AD JUSTABLE PAD	A240 304
4	GLAND	A276 316
6	PACKING	PTFE
7	PLUG	B148 C95800
8	PLUG SCREW	A276 316
9	GASKET	SPIRAL WOULD GRAPHITE/316
10	BOLT	A4-70
11	WASHER	A240 304

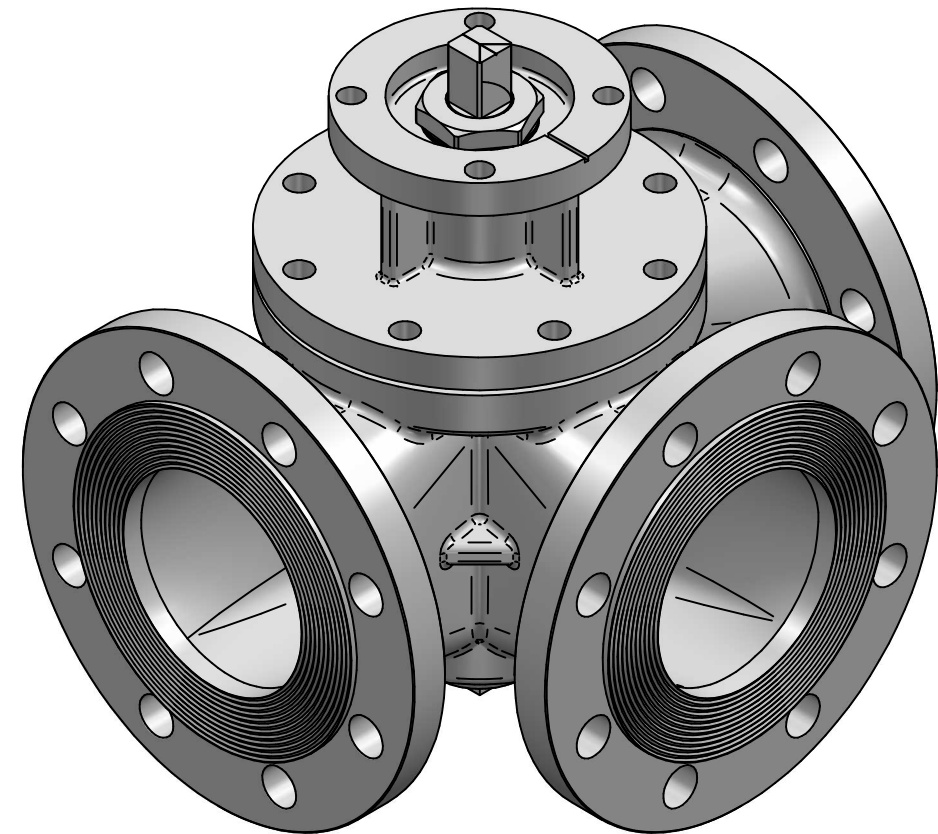

TITLE 3-WAY CONTROL VALVE, DN100, DIN FLANGE, PN16
 BODY&BONNET: A216 WCB; TRIM: SB148 C95800;
 BARE SHAFT; COLOR: RAL9010 PURE WHITE

	NAME	DATE	SIZE	DWG NO
DRAWN	MOTO	03.03.2020	A3	PON00004
CHECKED	ORLA	03.03.2020	FILE NAME: PON00004.dft	
ENG APPR	TOCO	dd.mm.yyyy	SCALE: 1:3	REV:
MGR APPR	TOCO	dd.mm.yyyy	WEIGHT:	SHEET: 1 OF 1

UNLESS OTHERWISE SPECIFIED
 DIMENSIONS ARE IN MILLIMETERS
 AND TOLERANCES ARE +/-0,5

REV	DESCRIPTION	DATE	APPROVED
REVISION HISTORY			