



Valve air unit essential to provide clean and dry supply air to valve positioners, solenoid valves and pneumatic actuators

Features

- ▶ Rugged aluminum die-cast or stainless steel 316 housing
- ▶ Excellent stability and repeatability
- ▶ Outstanding sensitivity with precise setting
- ▶ High capacity with 5 micron filter
- ▶ Self-relief function to balance output and setting pressures
- ▶ High flow capacity
- ▶ Optional auto-drain (float type)

Specifications

Model	FR-20	FR-21
Port Size	PT(Rc) 1/4 or NPT 1/4	NPT 1/4
Fluid	Air	
Output Pressure Range	0 - 4 bar (60 psi) / 0 - 8 bar (120 psi)	
Max. Supply Pressure	15 bar (225 psi)	
Operating and Fluid Temperature	-20°C to +70°C	
Supply Air	Filtered compressed, dry and non oiled air (up to 5 micron)	
Gauge Port Size	PT(Rc) 1/8	
Filtration	5 micron	
Housing Material	Aluminum die-cast	Stainless steel 316
Pressure Gauge Material	Stainless steel	
Weight	0.65 kg	1.4 kg

Dimensions

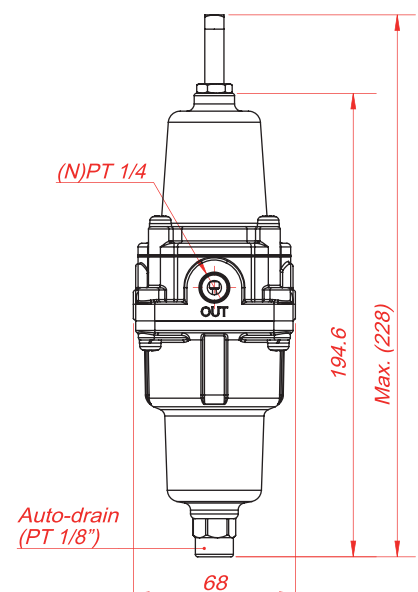
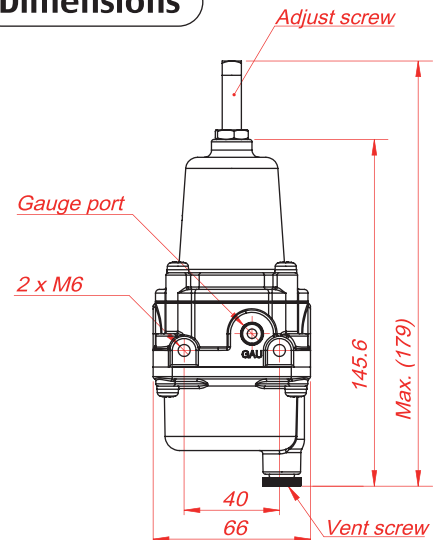

How to Order

FR Body Material - Port Size Output Pressure Range Operating Temp. - Options

Description	Code	
Body Material	20 : Aluminum die-cast 21 : Stainless steel 316	
Port Size	R : PT(Rc) 1/4	N : NPT 1/4
Output Pressure Range	1 : 0 - 4 bar (60 psi)	2 : 0 - 8 bar (120 psi)
Operating Temperature	0 : -20 - +70°C	1 : -20 - +120°C
	2 : -40 - +80°C	
Options	M : Manual drain	A : Auto drain