

DETAIL A  
1,5:1

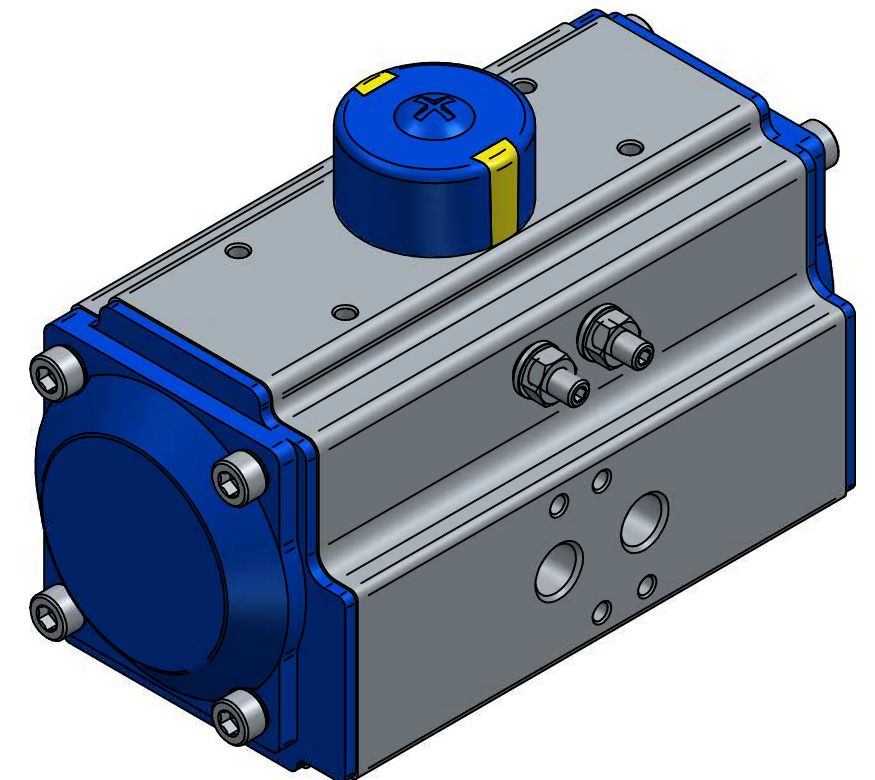

TITLE PNEUMATIC ACTUATOR DOUBLE ACTING,  
51NM@7BAR ALUMINIUM BODY&PISTON,  
◇14X17-F05/F07

	NAME	DATE	SIZE	DWG NO
DRAWN	HESG	11.11.2020	A3	NUTNKD-063.pdf
CHECKED	ORLA	dd.mm.yyyy	FILE NAME: NUTNKD-063.dft	
ENG APPR	TOCO	dd.mm.yyyy	SCALE: 1:2	REV: .....
MGR APPR	TOCO	dd.mm.yyyy	WEIGHT:	SHEET: 1 OF 1

UNLESS OTHERWISE  
SPECIFIED  
DIMENSIONS ARE IN  
MILLIMETERS  
AND TOLERANCES ARE  
+/-0,5

REV	DESCRIPTION	DATE	APPROVED
REVISION HISTORY			