

No.	Part Name	Material	Qty.
1	Body	Cast Iron	1
2	Disc	Aluminum Bronze	1
3	Stem	Stainless Steel	1
4	Seat	BUNA-N	1

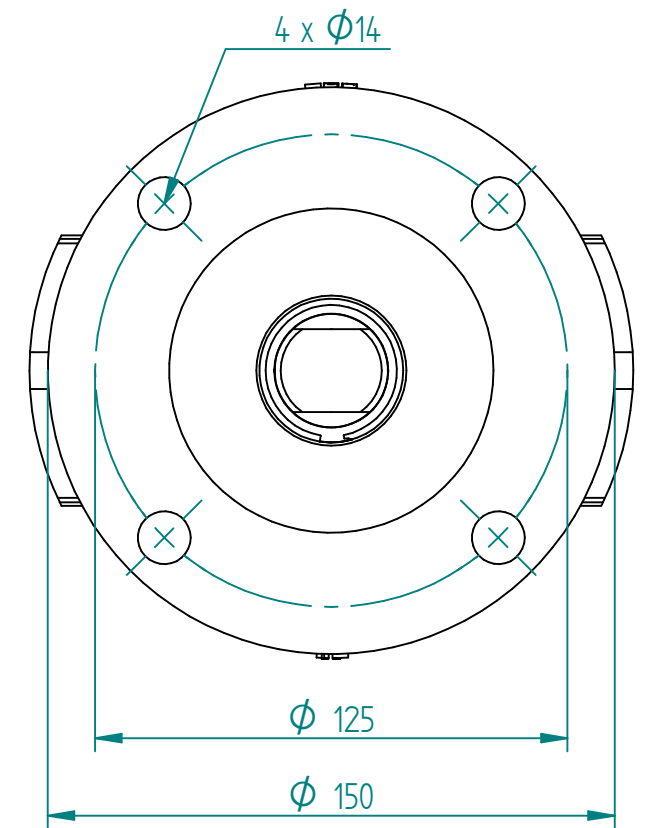

1:2 Top Plate



		NAME	DATE	SIZE	DWG NO
DRAWN		MOTO	11.08.2014	A3	BRA00111
CHECKED		TOCO	11.08.2014	FILE NAME: BRA00111.dft	
ENG APPR		TOCO	dd.mm.yyyy	SCALE: 1:3	REV:
MGR APPR		TOCO	dd.mm.yyyy	WEIGHT: 22,0 kg	SHEET: 1 OF 1

UNLESS OTHERWISE SPECIFIED DIMENSIONS ARE IN MILLIMETERS AND TOLERANCES ARE +/-0,5

REV	DESCRIPTION	DATE	APPROVED
REVISION HISTORY			

TITLE BUTTERFLY VALVE BRAY S30/684 COCENTRIC WAFER 10" PN10