

RC 200

High reliability pneumatic actuators

REMOTE CONTROL has been manufacturing pneumatic actuators in Sweden since 1961.

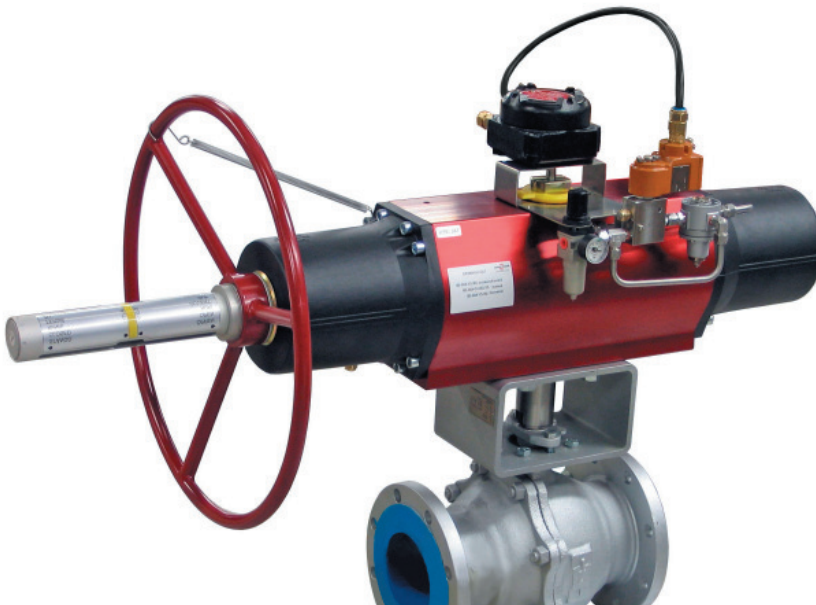

RC 200 series actuators are unique by design through the use of our Scotch Yoke technology on everything from the smallest RC 210 to the largest.

Our customers appreciate the technical benefits of the RC 200 actuators for a wide range of process environments. Scotch Yoke technology gives higher torque in the end positions, which is essential when valves are shut for long periods of time and require more torque during the initial operation. RC 200 actuators are smooth operating and have soft starting and finishing rotary motion to significantly protect and extend valve's working life.

The RC series is fitted exclusively with our RC-M1 manual override, a solution which is regarded as the best on the market (see p. 4).

The RC 200 series meets all international standards for fast, easy fitting of actuators to valves and accessories such as solenoid valves, end switches, position sensors, etc.

Valves and actuators are assembled quickly and easily at any of our workshops worldwide. They can also be installed out on site at our customers' premises.

Remote Control is a Swedish company with its own international subsidiaries and workshops in Germany, Great Britain, Singapore and the USA.

Technical Data

- 10 Nm – 8,000 Nm.
90 lbf. in. – 71,000 lbf. in.
On – Off and modulating
Double-acting or Single-acting with spring return.
- Max pressure: 10 bar/ 145 psi
Temp: -20 °C to +80 °C
-5 °F to +175 °F
Low temp: -40 °C to +60 °C
-40 °F to +140 °F
High temp: 0 °C to +150 °C
+30 °F to +300 °F
- Mounting face according to international standard
ISO5211, DIN3337, DIN79, NAMUR, VDI/VDE 3845.
- Mounting kits for all 90° valves and accessories.
- Spring cartridge with pre-tensioned springs.
Blow-off-proof drive shaft.
- Scotch Yoke provides increased torque in the end positions, smooth action, precise control, low air consumption and compact dimensions.
- High-quality materials for long working life and optimum corrosion proofing. Extruded anodised aluminium housing, RC 210 -260 have drive shafts and screws of stainless steel.
- Long life, maximum reliability and three-year warranty.

www.remotecontrol.se



Remote Control Sweden
Tel +46 (0)23 587 00
Fax +46 (0)23 587 45
www.remotecontrol.se
info@remotecontrol.se



Remote Control
Tel +49 (0)2131 795 760
Fax +49 (0)2131 795 7615
www.remotecontrol.de
info@remotecontrol.de



Remote Control Ltd
Tel +44 (0)1889 576 888
Fax +44 (0)1889 577 676
www.remotecontrol.co.uk
info@remotecontrol.co.uk



Remote Control Asia
Tel +65 6848 7150
Fax +65 6746 5815
www.remotecontrol.com.sg
info@remotecontrol.com.sg



Remote Control Inc
Tel +1 (0)401 294 1400
Fax +1 (0)401 294 3388
www.rciactuators.com
sales@rciactuators.com

RC200 - The flexible power package

Quality - Strength - Reliability

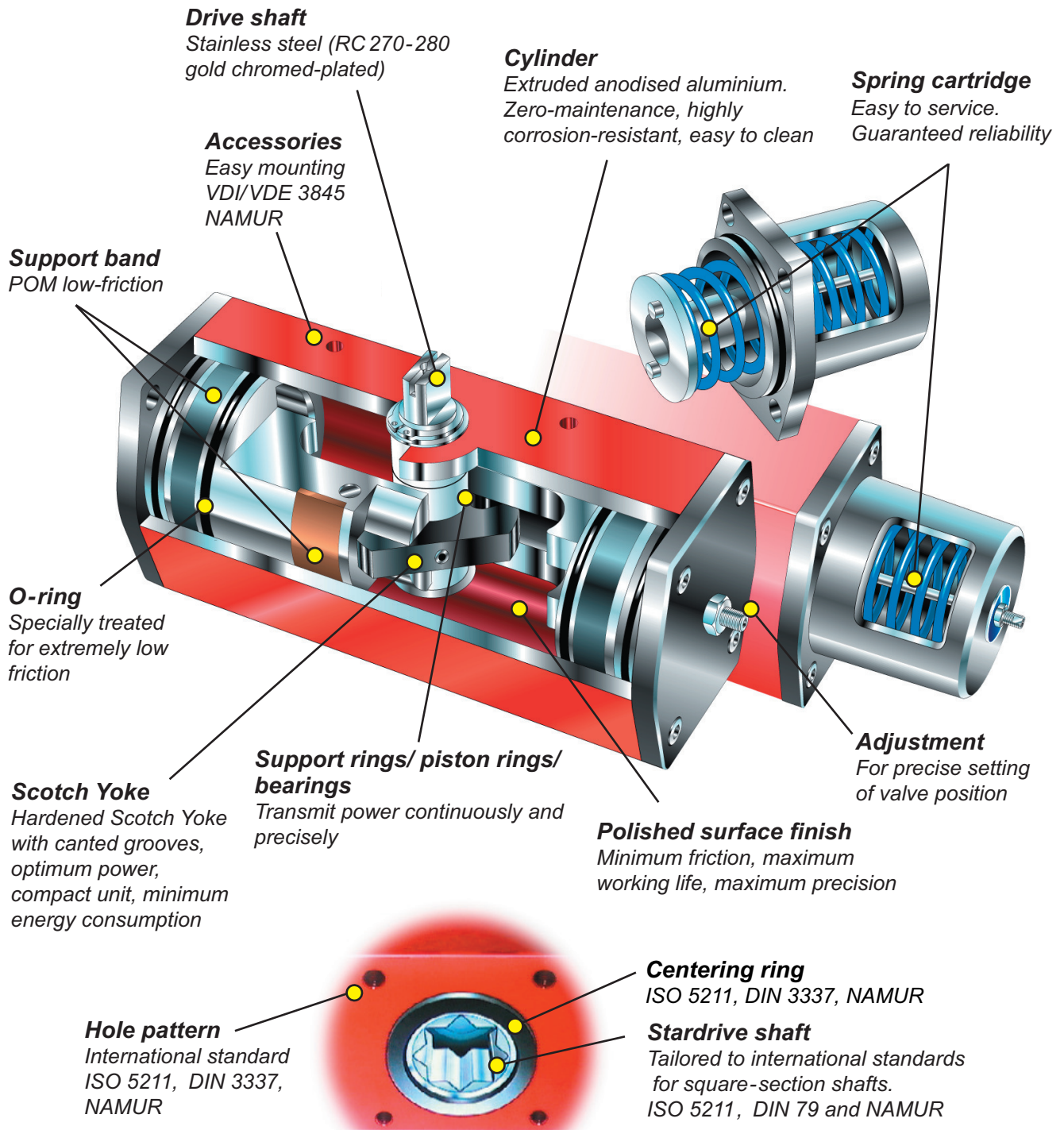

www.remotecontrol.se



Remote Control Sweden
Tel +46 (0)23 587 00
Fax +46 (0)23 587 45
www.remotecontrol.se
info@remotecontrol.se



Remote Control
Tel +49 (0)2131 795 760
Fax +49 (0)2131 795 7615
www.remotecontrol.de
info@remotecontrol.de



Remote Control Ltd
Tel +44 (0)1889 576 888
Fax +44 (0)1889 577 676
www.remotecontrol.co.uk
info@remotecontrol.co.uk



Remote Control Asia
Tel +65 6848 7150
Fax +65 6746 5815
www.remotecontrol.com.sg
info@remotecontrol.com.sg



Remote Control Inc
Tel +1 (0)401 294 1400
Fax +1 (0)401 294 3388
www.rciactuators.com
sales@rciactuators.com

Quality - Strength - Reliability

Quality

All RC actuators are made under strict quality control. We are certified to ISO 9001 and ISO 14001.

Our RC actuators comply with all standard international requirements, and all our products are CE-marked according to PED and ATEX. The recognised high quality of our RC actuators ensure our customers get top class actuating. We are proud to be able to give the unique RC warranty of three years!

Strength

RC actuators are strong. RC 200 with Scotch Yoke gives at least 50% more torque in the end positions, precisely where valves need it most. This ensures that valves work even after prolonged standstills.

RC 200 actuators have the lowest weight and smallest external dimensions for their torque output. Giving compact, light valve and actuator units, especially when using RC-M1 manual override. This reduces stresses on pipe work, especially when there is vibration in the pipe system.

Another benefit to our customers is that RC 200 actuators use less stroke volume than equivalent rack and pinion actuators, a major saving when you consider what compressed air costs.

Reliability

Simple, robust design. We use only top-quality materials in production, so our actuators last.

Our RC-M1 manual override unit is the best solution on the market. It is integrated in the endcap of the RC 200 actuator. To find out more about the benefits of the RC-M1 unit, go to page 4.

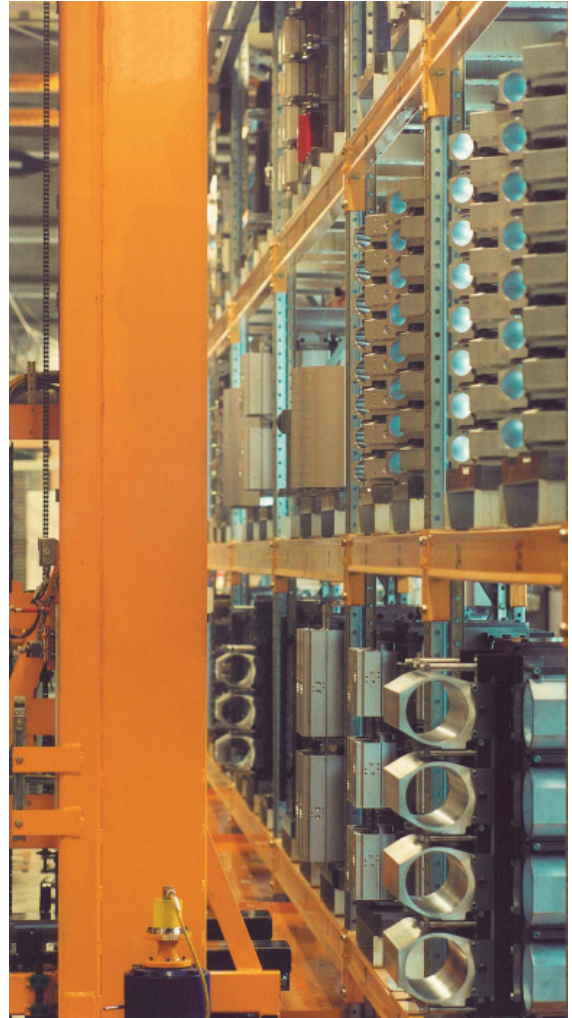

RC 200 actuators are manufactured around the clock using State-Of-The-Art automated CNC machinery.

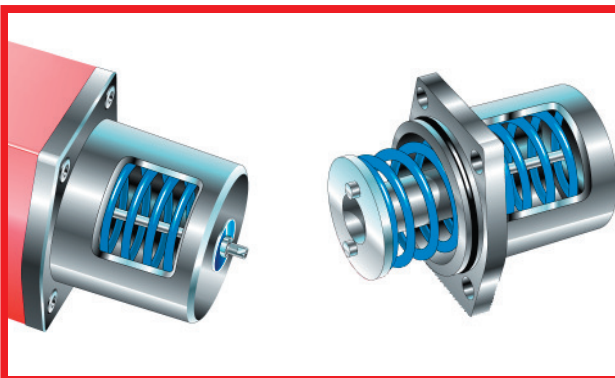

RC 200-SR spring return

Remote Control is always out in front when it comes to technology. Customers who switch to RC 200-SR have told us about the problems they had with other actuators and their small, weak springs. In contrast, all RC 200-SR actuators come with powerful pre-tensioned springs which are simple and easy to use. RC 200-SR with its powerful return springs ensures that springs shut or open by air failure.

www.remotecontrol.se



Remote Control Sweden
Tel +46 (0)23 587 00
Fax +46 (0)23 587 45
www.remotecontrol.se
info@remotecontrol.se



Remote Control
Tel +49 (0)2131 795 760
Fax +49 (0)2131 795 7615
www.remotecontrol.de
info@remotecontrol.de



Remote Control Ltd
Tel +44 (0)1889 576 888
Fax +44 (0)1889 577 676
www.remotecontrol.co.uk
info@remotecontrol.co.uk



Remote Control Asia
Tel +65 6848 7150
Fax +65 6746 5815
www.remotecontrol.com.sg
info@remotecontrol.com.sg



Remote Control Inc
Tel +1 (0)401 294 1400
Fax +1 (0)401 294 3388
www.rciactuators.com
sales@rciactuators.com

RC 200-M1 Manual override unit

The best solution on the market



**RC260-SR M1
RC1990**

Remote Control has the smart, intelligent, cost-effective design for a manual override, the RC-M1. It is integrated in the endcap of the RC unit, and can be fitted to all RC 200-DA and -SR units, from large to small. The wheel does not rotate, but remains stationary during operation.

Our customers opt for the RC 200 units with RC-M1 manual override when they want a compact unit with minimum weight and installation size. The installation height is the same as a normal RC actuator, and the top is free for easy mounting of accessories. See the comparative weights and dimensions for the RC-M1 and rack and pinion actuators with intermediate gear box.



RC240-SR M1

With the RC-M1, actuator and valve can be locked in any end position. This is for example a good way of ensuring valves are closed when servicing pipes.

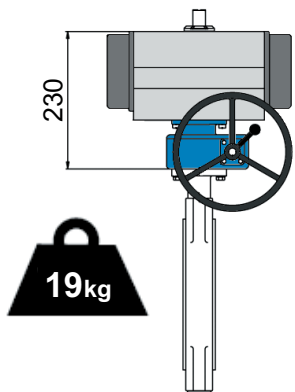

**Rack and pinion actuator
with intermediate gear box**

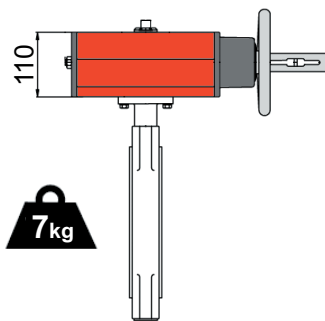

RC240-DA M1

Compare for yourself and see the benefits of the RC-M1 manual override unit.

Butterfly valve DN 200 with double-acting actuator and manual override. The RC 240-DA M1 measures just 110 mm and the actuator with the manual override weighs only 7 kg. An equivalent rack and pinion actuator with intermediate gear box measures 230 mm and weights a massive 19 kg.



Remote Control Sweden
Tel +46 (0)23 587 00
Fax +46 (0)23 587 45
www.remotecontrol.se
info@remotecontrol.se



Remote Control
Tel +49 (0)2131 795 760
Fax +49 (0)2131 795 7615
www.remotecontrol.de
info@remotecontrol.de



Remote Control Ltd
Tel +44 (0)1889 576 888
Fax +44 (0)1889 577 676
www.remotecontrol.co.uk
info@remotecontrol.co.uk



Remote Control Asia
Tel +65 6848 7150
Fax +65 6746 5815
www.remotecontrol.com.sg
info@remotecontrol.com.sg



Remote Control Inc
Tel +1 (0)401 294 1400
Fax +1 (0)401 294 3388
www.rciactuators.com
sales@rciactuators.com

Demanding installations

Strong and reliable

Our customers choose RC actuators, for even the most demanding applications. Remote Control meets all specifications and supplies top-quality actuators.

Here we show some examples of RC units suitable for both offshore and onshore use. Many examples and references are available such as RC 200 'fire safe' units with protective fire insulation and RC 200 quick actuators for turbin control.

Get in touch with us when you need actuators for more demanding applications.



RC200

Available epoxy-painted to NORSOK Offshore standards or other customer specifications.



RCG

Epoxy-painted cast iron cylinder. High torque output up to 15,000 Nm / 132,750 lbf. in.



RCT

Cylinder and spring housing are hard anodised and PTFE sealed for optimum corrosion resistance. A good alternative to steel or stainless steel. Good for use in corrosive environments such as offshore and petrochemicals.



RC88

Aluminium cylinder. High torque output up to 7,600 Nm / 67,260 lbf. in.



RCC

Epoxy-painted steel actuator. For conditions where a high level of corrosion proofing is required, where non-aluminium actuators are specified. Up to 150,000 Nm / 1,327,500 lbf. in.



Remote Control Sweden
Tel +46 (0)23 587 00
Fax +46 (0)23 587 45
www.remotecontrol.se
info@remotecontrol.se



Remote Control
Tel +49 (0)2131 795 760
Fax +49 (0)2131 795 7615
www.remotecontrol.de
info@remotecontrol.de



Remote Control Ltd
Tel +44 (0)1889 576 888
Fax +44 (0)1889 577 676
www.remotecontrol.co.uk
info@remotecontrol.co.uk



Remote Control Asia
Tel +65 6848 7150
Fax +65 6746 5815
www.remotecontrol.com.sg
info@remotecontrol.com.sg



Remote Control Inc
Tel +1 (0)401 294 1400
Fax +1 (0)401 294 3388
www.rciactuators.com
sales@rciactuators.com

RC200 - Fitting accessories

ISO - DIN - NAMUR

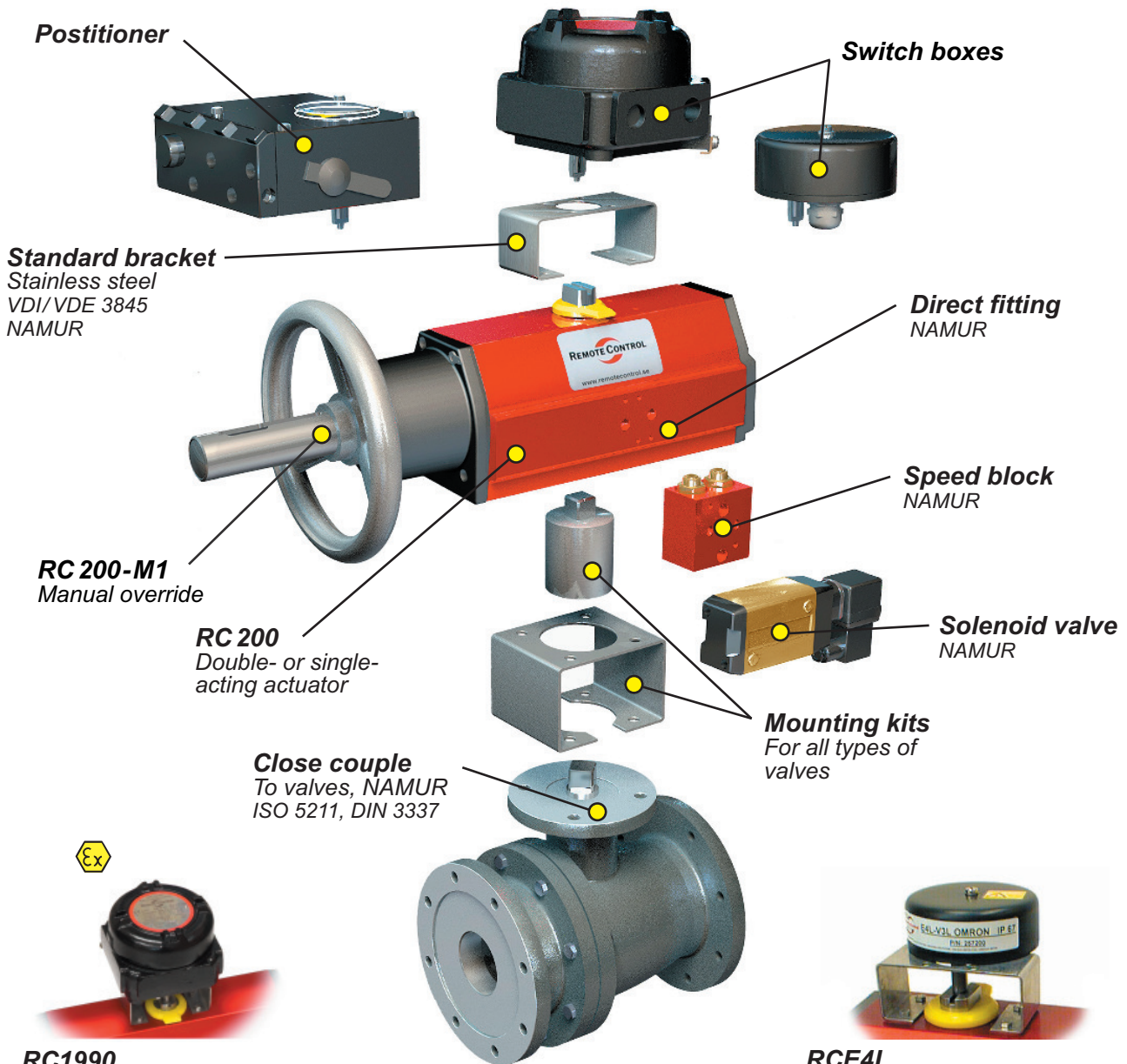

Positioner

Switch boxes

Standard bracket
Stainless steel
VDI/VDE 3845
NAMUR

Direct fitting
NAMUR

RC 200-M1
Manual override

Speed block
NAMUR

RC 200
Double- or single-
acting actuator

Solenoid valve
NAMUR

Close couple
To valves, NAMUR
ISO 5211, DIN 3337

Mounting kits
For all types of
valves



RC1990
Switch box, intrinsically safe
IP66/67

Temp: -50 °C to +110 °C / -58 °F to +230 °F
 ⚠ II 2 GD EEx d IIC T4, T5, T6
 Temp: -55 °C to +80 °C / -67 °F to +176 °F
 ⚠ II 2 GD EEx ib IIC T5, T6
 GOST R51330.0-99/R51330.1-99

RCE4L
Switch box
IP67

Option: ⚠ II 2 GD T80 / 100 °C
 EEx ib IIC T6 / T5

www.remotecontrol.se



Remote Control Sweden
 Tel +46 (0)23 587 00
 Fax +46 (0)23 587 45
www.remotecontrol.se
info@remotecontrol.se



Remote Control
 Tel +49 (0)2131 795 760
 Fax +49 (0)2131 795 7615
www.remotecontrol.de
info@remotecontrol.de



Remote Control Ltd
 Tel +44 (0)1889 576 888
 Fax +44 (0)1889 577 676
www.remotecontrol.co.uk
info@remotecontrol.co.uk



Remote Control Asia
 Tel +65 6848 7150
 Fax +65 6746 5815
www.remotecontrol.com.sg
info@remotecontrol.com.sg



Remote Control Inc
 Tel +1 (0)401 294 1400
 Fax +1 (0)401 294 3388
www.rcactuators.com
sales@rcactuators.com

RC fittings

Control equipment

Solenoid valves are available for all voltages, in standard or Ex-proof versions. RC actuators can be fitted with the RC speed control unit. RC 200 DA and SR can be controlled by pneumatic or electro-pneumatic valve position controls.

Installation

Remote Control's mounting kits are ideally suited to fitting actuators to valves, ensuring reliable operation and long life. We offer installation and testing at the client's premises or at any of our workshops.

Training

To ensure our products are used correctly and effectively, we offer product training on site at the customer's premises when commissioning or at Remote Control companies anywhere in the world.

Indicators

RC200 actuators have indicators showing the valve position. Remote Control makes and supplies a large number of switch boxes of different designs. Of course we assemble equipment to suit Customers' wishes and specifications.

Field bus

RC actuators can be connected to all the field bus systems on the market; InterBus, DeviceNet, CAN, Modbus, Foundation Fieldbus, Profibus PA, Profibus DP, AS-Interface etc.

Service

Our factory trained engineers can assist you with installation and commissioning, service and maintenance.

All Remote Control actuators are

- **100% leak and functional tested**
- **Marked according to international standards**
- **Delivered with instructions in all EU languages**

RC 200 designs

Temperature range

Standard: -20°C to +80°C / -5°F to +175°F
Low temp: -40°C to +60°C / -40°F to +140°F
High temp: 0°C to +150°C / +30°F to +300°F

RC 200 meet standards

Solenoid valve connection: NAMUR
Fitting accessories: VDI/VDE 3845, NAMUR
Fitting to valve: Hole pattern, centering ring
ISO 5211, DIN 3337, NAMUR
Stardrive shaft: ISO 5211 with 90° □ and
DIN 79 with 45° ◇ and NAMUR

RC200 are CE-marked

According to PED and ATEX.

Quick acting RC 200 actuators

For extremely short operating times.

Pressure ranges

RC 200-DA: 2-10 bar / 30-145 psi
RC 200-SR: 2-10 bar / 30-145 psi

Extra corrosion protection

RCT hard anodised actuators
Epoxy finished
Offshore or other finish to meet customer specifications.
Stainless screws and drive shaft
(standard for RC 210-260)

Operating medium

Air, inert gases (non-dangerous fluids, group 2 according to directive PED 97/23/EC)
RC 200 actuators also available for Water or oil hydraulics: 2-10 bar / 30-145 psi



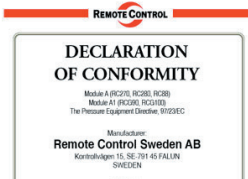

CE-marking according to the Pressure Equipment Directive PED 97/23/EC



Environment Control ISO 14001:2004



Quality Assurance ISO 9001:2000

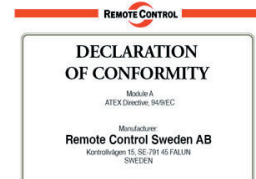

CE-marking according to the ATEX Directive 94/9/EC



The national reference laboratory Force Technology in Vejen, Denmark. Calibration of gas flow meters.



Remote Control
Unit 40, Trent Valley Works
Station Road, Rugeley
Staffordshire WS15 3HB
England
Tel +44 (0)1889 576 888
Fax +44 (0)1889 577 676
www.remotecontrol.co.uk
info@remotecontrol.co.uk



Remote Control
No. 9, Kaki Bukit Road 1
#03-03, Eunos Technolink
Singapore 415938
Tel +65 6848 7150
Fax +65 6746 5815
www.remotecontrol.com.sg
info@remotecontrol.com.sg



Remote Control
PO Box 355
386 Dry Bridge Rd
North Kingstown, RI 02852
USA
Tel +1 (0)401 294 1400
Fax +1 (0)401 294 3388
www.rciactuators.com
sales@rciactuators.com



Remote Control
Gutenbergstr. 22
DE-41564 Kaarst-Büttgen
Germany
Tel +49 (0)2131 795 760
Fax +49 (0)2131 795 7615
www.remotecontrol.de
info@remotecontrol.de



Remote Control
Kontrollvägen 15
SE-791 45 Falun
Sweden
Tel +46 (0)23 587 00
Fax +46 (0)23 587 45
www.remotecontrol.se
info@remotecontrol.se



RC Twin Power
Multi-turn Pneumatic/Hydraulic
Actuator
Up to 800 Nm
7,080 lbf. in.



RCC
Pneumatic Steel Actuator
Up to 150,000 Nm
1,327,500 lbf. in.



RCEL
Electric Actuator
Up to 2,450 Nm
21,680 lbf. in.