

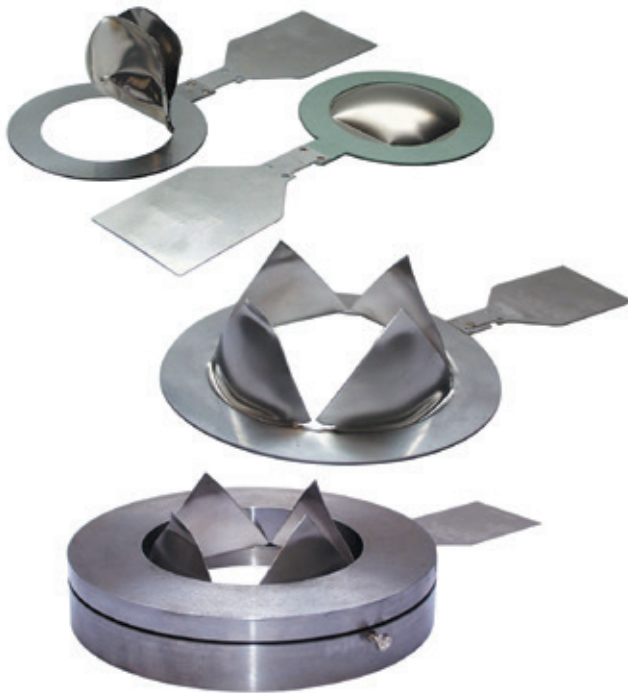

MARSTON BURSTING DISCS

A complete range of non-reclosing pressure relief devices, from simple conventional designs through composite assemblies to top-of-the-range reverse buckling discs



FEATURES

- Single action devices that offer the ultimate over-pressure protection for vessels.
- React to pressure differences between the process and the vent.
- Can be manufactured to almost any recognized standard bore diameter, depending on the bursting pressure, operating pressure and related temperatures.
- Special bore diameters available to meet specific constraints.
- Broad range of materials options.
- Wide range from simple forward acting tensile loaded assemblies to grooved reverse-buckling compression loaded units.
- Design options include simple single discs clamped directly between flanges or complex multi-disc assemblies including both reverse buckling primary discs and conventional secondary discs with high capability reverse pressure supports.

GENERAL APPLICATIONS

Bursting discs are suitable for use in any on or offshore industry that uses a pressurized system, particularly chemical, oil and gas, pharmaceutical, plastics and rubber. Also for cryogenic systems, the food industry, electrical switchgear protection and the transportation of gases, liquids or powders.

TECHNICAL DATA

Materials: Metals, fluoropolymers, graphite or a combination of these
Sizes: 0.12" to 43" (3 to 1100 mm)
Pressure range*: 0.58 to 1813 psig (.04 to 125 barg)
Temperature range: -328° to 1112°F (-200° to 600°C)

*Depending on design, size, material and temperature.

MARSTON BURSTING DISCS

INTRODUCTION

PRODUCT OVERVIEW

The Marston range of bursting disc designs provides cost-effective over-pressure protection. The designs range from simple single foil devices that can be used to relieve an extreme pressure variation - that is when a low pressure operation may be affected by a possible runaway situation and a relatively high pressure is generated. Under normal circumstances, the working pressure is a low percentage of the rated bursting pressure. More complex devices are available for applications where the operating pressure needs to be maximized within the design constraints of the vessel or system where, for example, it is desirable to operate within 5% of the rated pressure of the disc. The Marston range includes discs that would be suitable for both of these extremes and any intermediate application.

All pressurized systems, conforming to the appropriate National and International standards, are limited to a maximum overpressure during pressure relief. In accordance with the EC Pressure Equipment Directive (PED), all pressure equipment defined therein must have a pressure relief or control system that limits the maximum overpressure to 1.1 x the maximum allowable design pressure of the equipment. A bursting disc safety device is a recommended means for pressure relief, and in some cases the preferred device. It is also used as the ultimate safety device should other pressure limiting equipment fail to function correctly.

Benefits

Bursting discs are:

- Essentially leak-tight.
- Fully certified to a recognized National or International Standard.
- A convenient way of introducing a known level of pressure relief to a system.
- Often significantly more cost-effective than other pressure relief methods.
- A recognized way of protecting safety relief valves from the effects of product deposits and leakage. A corrosion-resistant bursting disc may allow the use of a standard relief valve in highly complex applications.

Bursting disc devices

Marston bursting discs provide a recognized method of protecting vessels or systems against the possibly catastrophic effects of excessive pressure. Low pressure bursting discs may also be used to protect vessels against the effects of high vacuum.

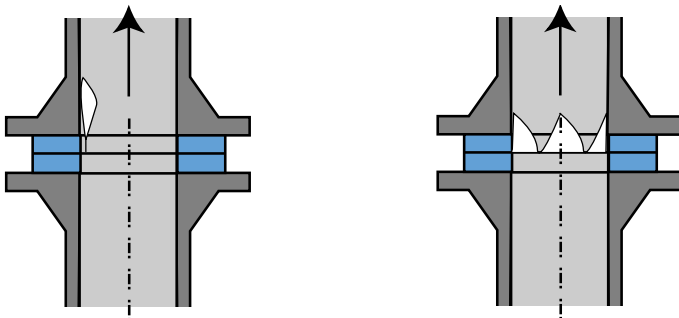

A bursting disc, often referred to as a rupture disc or a safety disc, is a non-reclosing pressure relief device. The resultant release of the contents from the protected system must be controlled in accordance with local, National and applicable EC/International rules and may necessitate the need for a fully-contained relief system.

The use of a correctly-designed bursting disc device, its correct assembly and fitting are essential. Bursting disc devices are often fragile and need to be handled with care. Normally, they require a dedicated holder assembly.

Bursting disc devices function due to the differential pressure applied across the disc. All pressures acting on the disc, including those induced by vent-side pressure, vacuum, system draining or cleaning, must be considered during specification.

Choosing the most appropriate bursting disc device for a particular application depends on a number of key factors. This guide has been designed to assist the disc selection process.

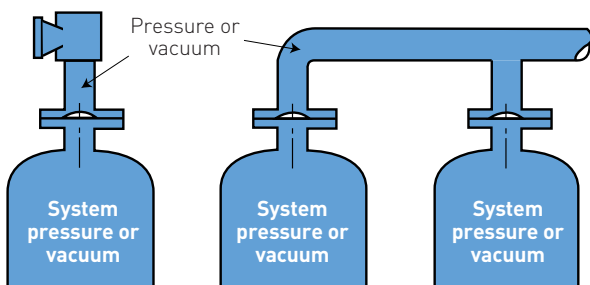

MARSTON BURSTING DISCS

IDENTIFICATION

PRODUCT IDENTIFICATION

Identification and traceability of the thousands of bursting discs and holders in use across the world today is critical.

Every Marston disc and holder carries a marking that can be traced back to its original manufacture.

Each bursting disc device is allocated a unique equipment number that provides exact identification.

All details of manufacture (including material identity for each item supplied) are recorded and archived. Details can be tracked back over 40 years.

HOLDER LABEL



The equipment number is shown on the holder label, disc assembly tag and also on the test certificate that is supplied with each batch of discs.

Following the original supply, subsequent batches of bursting discs add a suffix letter to the equipment number to provide batch identification.

Example:

Original supply:

Holder 'E' no. NT 1234

Bursting disc 'E' no. NT 1234

(including reverse pressure support if required)

First re-order of bursting discs 'E' no. NT 1234 / A

Second re-order of bursting discs 'E' no. NT 1234 / B

NOTE

The equipment number, together with an adequate description including bursting pressure and temperature, should be quoted for all replacement orders.



DISC TAG

MARSTON BURSTING DISCS

FOOLPROOFING

FOOLPROOFING FEATURES OF MARSTON TAGGED BURSTING DISC ASSEMBLIES

A wrongly installed bursting disc can be disastrous. For this reason, where possible, Marston bursting disc assemblies are fitted with a foolproofing feature which is incorporated within the disc tag and holder identity label.

Marston holders have a stainless steel identity label attached permanently which identifies the holder type and equipment number uniquely. It also indicates the correct holder orientation relative to flow.

The disc is fitted with a notched stainless steel tag as shown below. This identifies uniquely the disc type, its equipment number and batch, the rated bursting pressure and temperature, the design code and also indicates the vent side of the disc.

The combination of the notched tag and the offset identity label prevents incorrect assembly of the disc to the holder.

The holder also can be provided with installation inhibitors such as 'J' bolts. These prevent the holder from being installed incorrectly between the plant flanges. (See accessories on page 18 for details.) Other methods can be considered such as dowels or tongue and groove flanges, to ensure correct installation.

When these features are combined with comprehensive installation instructions, quick and simple installation is ensured.

The photographs show the offset label on the holder and the notch on one side of the neck of the disc identification tag.

These foolproofing features aid correct assembly and prevent incorrect assembly (as demonstrated in the two lower photographs).

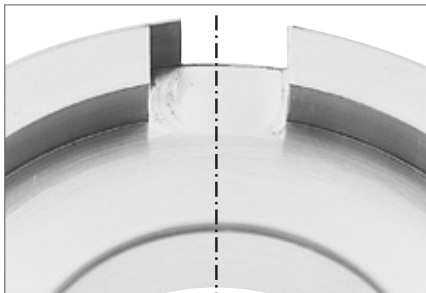

Offset label on holder

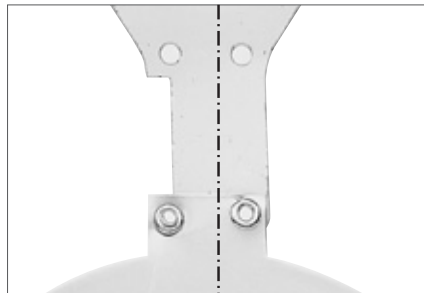

Notched disc tag

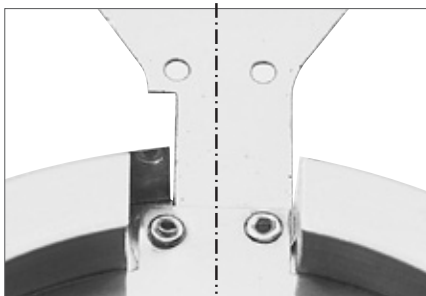

Correct assembly

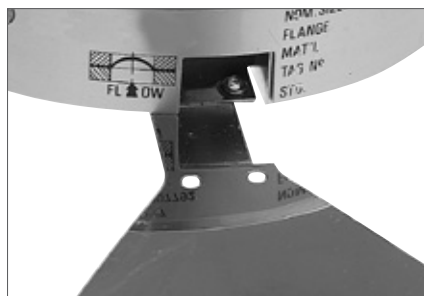

Incorrect assembly

MARSTON BURSTING DISCS

SIZING

The sizing of safety discs is based on equations that are derived from general gas and liquid flow equations. They assume that flow is critical.

The discharge capacity of a discharge system should be such as to ensure that under relieving conditions the maximum allowable working pressure, of the pressurized system to be protected, does not exceed the limits as governed by the appropriate regulation or standard.

The equations in this section give a simplified approach neglecting pressure drops in the inlet pipe and the discharge pipe.

They should only be used when it can be assumed safely that any pressure drops are negligible.

In such cases, the flow rate is controlled by the nozzle entry configuration of the equipment and the bursting disc device.

Where the system cannot be assumed safely to be suitable for the simplified approach or the flow is sub-critical, the user should refer to the appropriate standard.

These equations are only to be used with single phase flow. Should the state at flowing conditions be two-phase then specialist advice should be sought.

NOMENCLATURE AND GENERAL GAS PROPERTIES

Gas	Symbol	Molecular mass M	Isentropic coefficient k	Constant F
Acetylene	C ₂ H ₂	26.02	1.25	2.58
Air		28.96	1.40	2.70
Ammonia	NH ₃	17.03	1.31	2.64
Argon	Ar	39.91	1.66	2.86
Butane	C ₄ H ₁₀	58.08	1.11	2.48
Carbon dioxide	CO ₂	44.00	1.30	2.63
Carbon monoxide	CO	28.00	1.40	2.70
Chlorine	Cl ₂	70.91	1.35	2.66
Chlorodifluoromethane (Arcton 22)	CHClF ₂	86.47	1.18	2.55
Dichlorodifluoromethane (Arcton 12)	CCl ₂ F ₂	120.91	1.14	2.51
Dichlorotetrafluoroethane (Arcton 114)	[CCl(F ₂) ₂]	170.90	1.09	2.47
Ethane	C ₂ H ₆	30.05	1.22	2.57
Ethylene	C ₂ H ₄	28.03	1.25	2.60
Helium	He	4.00	1.63	2.85
Hydrogen	H ₂	2.02	1.41	2.71
Hydrogen chloride	HCl	36.46	1.41	2.71
Hydrogen sulphide	H ₂ S	34.08	1.32	2.65
Isobutane	CH(CH ₃) ₃	58.08	1.11	2.48
Methane	CH ₄	16.03	1.31	2.64
Methyl chloride	CH ₃ Cl	50.48	1.28	2.62
Nitrogen	N ₂	28.02	1.40	2.70
Nitrous oxide	N ₂ O	44.02	1.30	2.63
Oxygen	O ₂	32.00	1.40	2.70
Propane	C ₃ H ₈	44.06	1.13	2.51
Propylene	C ₃ H ₆	42.05	1.15	2.52
Sulphur dioxide	SO ₂	64.07	1.29	2.62
Trichlorofluoromethane (Arcton 11)	CCl ₃ F	137.37	1.14	2.51

NOMENCLATURE

A = required flow area (mm²)

d = required nominal bore (mm)

F = constant for gas factor which is a function of the isentropic coefficient and the ratio of absolute reverse pressure to absolute inlet pressure and also contains the numeric constants arising as a result of the system of units used.

f_v = viscosity correction factor. See relevant standard. For liquids with a viscosity equal to or less than water f_v = 1.

k = the isentropic coefficient at the inlet conditions (the ratio of the specific heats at standard temperature and pressure may be used).

M = molecular mass (kg/kmol)

P_b = absolute bursting pressure (bar)

P_r = absolute reverse pressure (bar)

Q = discharge mass flow (kg/hr)

T = inlet temperature (K)

v = volumetric mass (m³/kg)

Z = compressibility factor (see relevant standard). In many cases Z approximates to unity and may be ignored.

α = coefficient of discharge

ΔP = pressure drop (bar). (P_b - P_r)

ρ = density (kg/m³)

MARSTON BURSTING DISCS

SIZING

COMPRESSIBLE FLUIDS

The equations and nomographs shown here are limited to those systems where:

- The bursting disc device is installed within eight inlet pipe diameters from the entry to the equipment branch / nozzle.
- The bursting disc device discharge area is not less than 50% of the inlet pipe area.
- The length of the discharge pipe following the bursting disc device does not exceed five pipe diameters.
- The branch nozzle configurations are as given here.

The discharge coefficients for gases/vapours are:

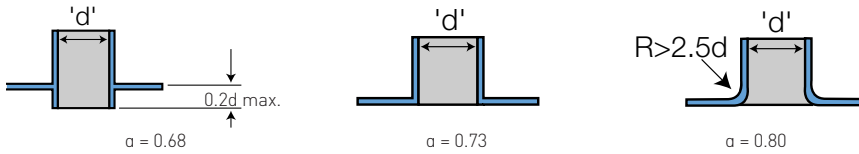

NOMOGRAPH FOR GASES

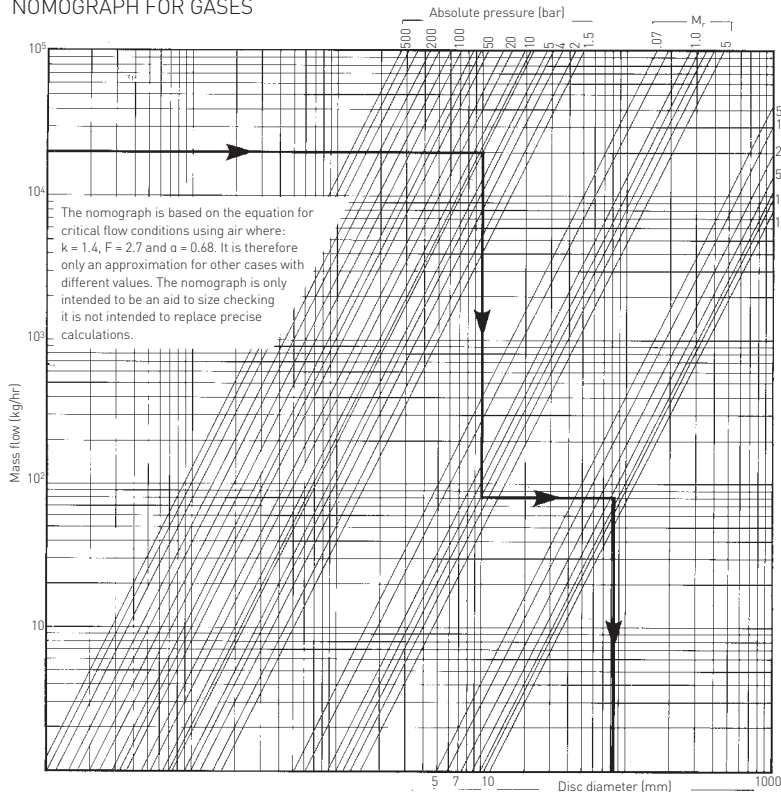

Equation for gases and vapours

The mass flow rate or the capacity of a bursting disc (Q), is calculated from the equation:

$$Q = A \cdot P_b \cdot F \cdot \alpha \cdot \sqrt{M/T \cdot Z}$$

Therefore the area required to discharge a given mass flow is given by the equation:

$$A = \frac{Q}{F \cdot \alpha \cdot P_b} \sqrt{\frac{T \cdot Z}{M}}$$

MARSTON BURSTING DISCS

SIZING

NOMOGRAPH FOR STEAM

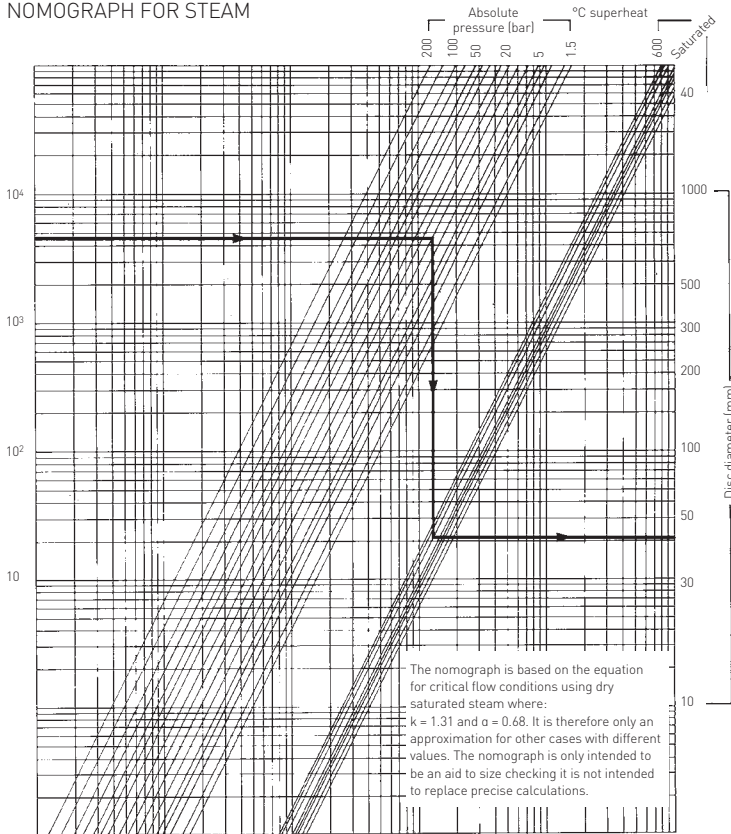

Equation for saturated or superheated steam
 The mass flow rate or the capacity of a bursting disc (Q), is calculated from the equation:

$$Q = 0.2883 \cdot A \cdot F \cdot \alpha \sqrt{(Pb/v)}$$

Therefore the area required to discharge a given mass flow is given by the equation:

$$A = \frac{Q}{0.2883 \cdot F \cdot \alpha} \sqrt{\frac{v}{Pb}}$$

INCOMPRESSIBLE FLUIDS

NOMOGRAPH FOR LIQUID

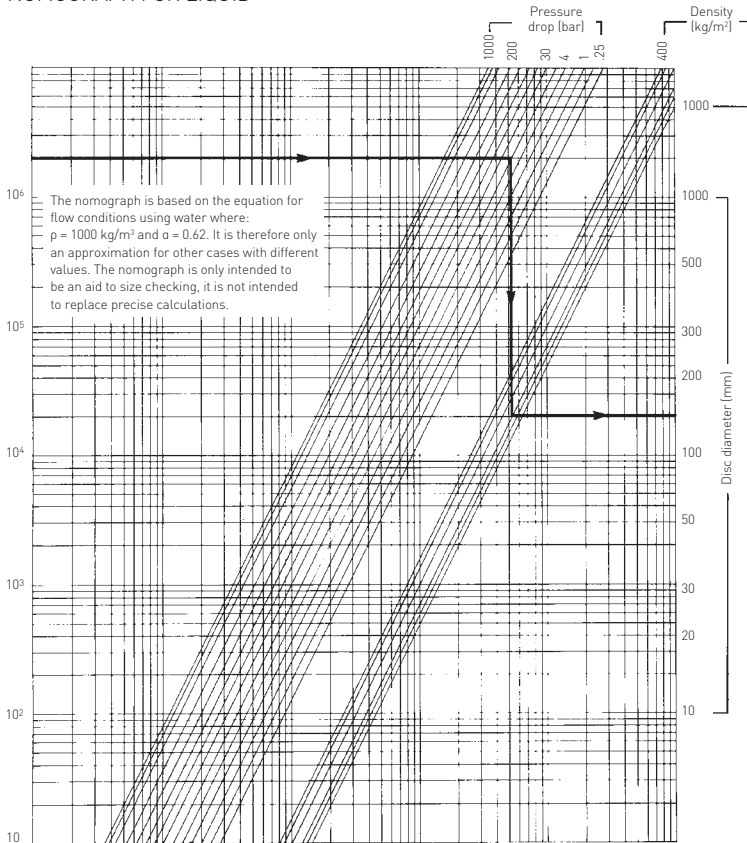

Equation for liquid
 For incompressible fluids as single phase flow at the inlet and not flashing to vapor either partly, or completely on venting. The mass flow rate or the capacity of a bursting disc (Q), is calculated from the equation:

$$Q = 1.61 \cdot A \cdot f\mu \cdot \alpha \sqrt{\Delta P \cdot \rho}$$

Therefore the area required to discharge a given mass flow is given by the equation:

$$A = \frac{Q}{1.61 \cdot f\mu \cdot \alpha \cdot \sqrt{\Delta P \cdot \rho}}$$

MARSTON BURSTING DISCS

SIZING

The discharge coefficients for incompressible fluids are:

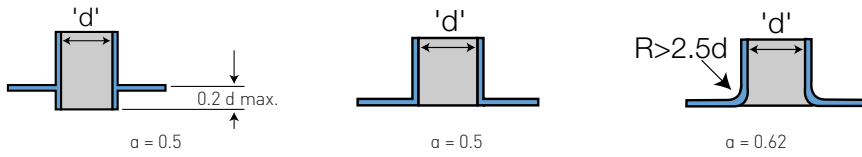

MARSTON SIZING PROGRAMME

The Marston computer programme aids the engineer when calculating- the required size or capacity of a disc, within the limitations given in this section and within the programme.

Wrongly sized venting can be dangerous. It is imperative that the user complies with the requirements of the relevant codes for the sizing and use of bursting discs, in particular, that the effect of any associated pipework or restriction is taken into account.

Restrictions within the disc assembly, such as vacuum supports, should also be considered.

Correct sizing for relief venting of a system is the responsibility of the end user.

MARSTON BURSTING DISCS

MATERIAL SELECTION

MATERIAL SELECTION

Normally materials will conform to those listed below. The asterisk * denotes standard materials. Where items are required to conform to the Pressure Equipment Directive, 97/23/EC, the holder materials will be chosen from an approved list of Harmonized materials.

TYPICAL MATERIALS USED IN THE MANUFACTURE OF BURSTING DISCS

Material category	British / European standards	Grades	International standards	UNS nos.
Stainless steel *	BS 970 / EN10222	316 / 316L	SA/A 240 - 316 / 316L	S30400
		321	SA/A 240 - 321 / 321L	S31600
Nickel 200 *		2.4060	SB/B 160	UNS 02200
Nickel 201		2.4060	SB/B 160	UNS 02201
Monel 400 *	BS 3074	2.4360	SB/B 127	UNS 04400
Inconel 600 *	BS 3074	2.4816	SB/B 166	UNS 06600
Hastelloy C276 *	DIN 17744	2.4602	SB/B 574 and 5	UNS 10276
Tantalum *	VDTÜV	382/507	B 364 R05200	UNS 005200
			R05252	UNS 005252
Aluminum*	BS 1470	3103	SB/B 209 - 6061 T6	A91060

Other materials include Graphite *, PTFE-FEP *, PTFE-PFA * and PTFE *
For advice regarding particular requirements, consult the factory.

TYPICAL MATERIALS USED IN THE MANUFACTURE OF BURSTING DISCS HOLDERS

Material category	British / European standards	Grades	International standards	UNS nos.
Carbon steel *			SA/A 105	
Stainless steel *	BS 970 Pt. 1 BS 970 Pt. 4	304	SA/A 479 - 304	F304L S30400
		316	SA/A 479 - 316	F316L S31600
		321		
Nickel 200	BS 3073	NA11	SB/B 161	UNS 02200
		NA11	SB/B 162	UNS 02201
Monel 400	BS 3074 BS 3076	NA13	SB/B 164	UNS 04400
		NA13	SB/B 165	
Inconel 600	BS 3074 BS 3076	NA21	SB/B 167	UNS 06600
		NA21	SB/B 168	
Hastelloy B2	DIN 17744	2.4617	SB/B 333 and 5	UNS 10665
Hastelloy C4	DIN 17744	2.4610	SB/B 574 and 5	UNS 06455
Titanium	DIN 17850 and 1	3.7025 3.7035	B 265 [Grades 1 and 2]	

Other materials include the super-austenitic and duplex stainless steels, glass-filled PTFE and graphite. A PTFE coating can be applied to provide both corrosion resistance and a non-stick surface. For more arduous applications, holders can be lined with corrosion resistant metals such as tantalum.

The range of allowed holder materials is covered by European Harmonized Standards and the ASME II and ASME VIII Codes. For advice regarding your particular requirements, consult the factory.

GASKET MATERIAL

Type	Material	Maximum pressure (at 20°C)	Maximum temperature
Flat gasket	AFM 34	100 bar	250°C
	AFM 30	100 bar	200°C
	Garfite	138 bar	550°C
	Gylon blue	55 bar	250°C
	PTFE	55 bar	250°C
O' ring	FKM	250 bar	150°C
	PTFE	350 bar	250°C
	Silver plated st. steel	1000 bar	600°C

The table lists the common jointing materials. It details the maximum pressures and temperatures at which they can be used.

MARSTON BURSTING DISCS

PRESSURE

GUIDE TO BURSTING PRESSURES

Bursting pressure capabilities for each type of bursting disc vary depending on the design, size, material and temperature.

Please consult one of our Sales Engineers for bursting pressures outside the tabulated ranges.

Minimum/maximum bursting pressures: barg at 20°C

DISC TYPES

Bore size mm	NT*		NTG*		Maxi	RBH			Mono		
	NR*	CS*	NRG*	vent	RBF	LRB	SRBH	RBX	GR	bloc	GRB
25	0.80	1.50	4.0	12.4	1.8	2.00	1.20	10.0	1.00	1.0	0.40
	125.00	125.00	125.0	450.0	380.0	380.00	100.00	150.0	17.20	56.0	15.00
40	0.60	1.00	2.6	7.0	1.2	1.80	0.90	7.5	0.52	0.5	
	83.00	83.00	83.0	315.0	380.0	380.00	65.00	115.0	17.20	42.0	
50	0.40	0.75	2.0	5.5	0.9	1.60	0.60	5.0	0.275	0.4	0.14
	72.00	72.00	72.0	255.0	380.0	380.00	50.00	75.0	17.20	28.0	10.00
65	0.35	0.65	3.4	4.8	0.8	1.40	0.50	4.0	0.24	0.4	
	50.00	50.00	50.0	210.0	175.0	175.00	40.00	60.0	16.50	24.0	
80	0.30	0.50	2.5	3.4	0.7	1.25	0.40	3.1	0.21	0.3	0.10
	41.00	41.00	41.0	170.0	120.0	120.00	40.00	60.0	15.50	20.0	4.50
100	0.20	0.35	1.9	3.0	0.6	1.25	0.30	2.5	0.14	0.2	0.04
	36.00	36.00	36.0	100.0	90.0	90.00	30.00	50.0	10.30	14.0	2.50
150	0.14	0.30	1.4	2.0	0.5	1.00	0.25	1.7	0.07	0.2	0.04
	20.00	20.00	20.0	100.0	60.0	60.00	20.00	30.0	5.50	10.5	1.50
200	0.10	0.25	1.4	1.7	0.5	1.00	0.20	1.2	0.07	0.1	
	18.00	18.00	18.0	30.0	50.0	50.00	12.50	25.0	3.45	5.5	
250	0.10	0.20	1.4	1.7	0.5	1.00	0.20	1.0	0.07	0.1	
	12.50	12.50	12.5	25.0	40.0	40.00	10.00	20.0	2.15	4.5	
300	0.07	0.20	1.4	1.7	0.5	1.00	0.20	1.0			
	10.00	10.00	10.0	18.0	35.0	35.00	10.00	15.0			
350	0.07	0.15	1.4	1.7	0.5	1.00	0.20	1.0			
	9.50	9.50	9.5	18.0	27.5	27.50	8.50	15.0			
400	0.07	0.12	1.4	1.4	0.5	1.00	0.20	1.0			
	9.00	9.00	9.0	18.0	20.0	20.00	7.50	12.0			
450	0.07	0.10	1.4	1.0	0.5	1.00	0.20	1.0			
	7.00	7.00	7.0	16.0	17.0	17.00	7.00	10.0			
500	0.07	0.07	1.4	1.0	0.5	1.00	0.20	1.0			
	6.00	6.00	6.0	14.0	14.0	14.00	6.00	10.0			
550	0.07	0.07		1.0				1.0			
	5.50	5.50		12.0				10.0			
600	0.07	0.10		0.8				1.0			
	5.00	5.00		10.0				10.0			
750	0.07	0.10									
	4.00	4.00									

* Maximum pressures are for standard designs.
For higher pressures a welded construction is available.

MARSTON BURSTING DISCS

TEMPERATURE

TEMPERATURE RANGES

Materials for bursting discs have a limited allowable working temperature range. The table indicates the normal limits for commonly used bursting disc materials. The limitations of joint sealing materials must be considered as well as possible corrosion from the process or environmental conditions that prevail.

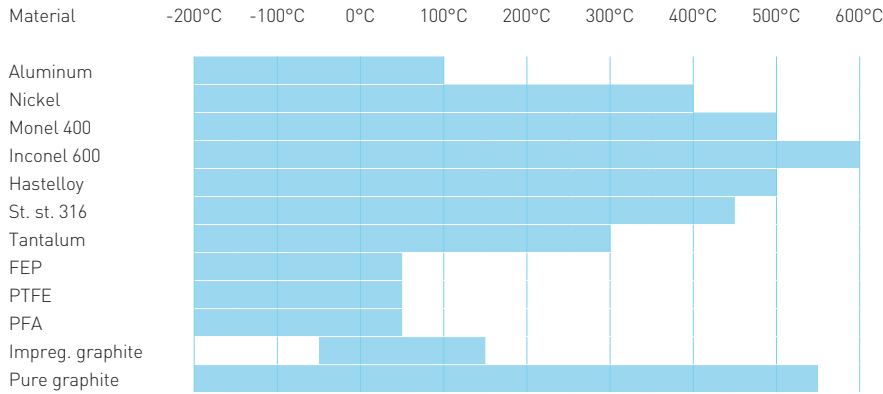

INFLUENCE OF TEMPERATURE

Bursting disc materials are affected by changes to temperature. In general, higher temperatures induce a reduction of strength and consequently bursting pressure.

The following graphs show the typical effect of temperature on various bursting disc materials for forward-acting discs:

Generally, reverse buckling discs are affected by temperature changes less than equivalent forward acting discs. Each batch of reverse buckling discs will be affected differently, by factors other than just the material. Therefore, a 'typical' temperature effect graph is not considered to be helpful.

Where operating conditions dictate its use, a heat shield can be fitted between the disc material and the process to provide a thermal barrier. This may be to preserve the disc integrity or to reduce heat loss.

TEMPERATURE EFFECT FOR COMPOSITE SLOTTED TYPE DISCS

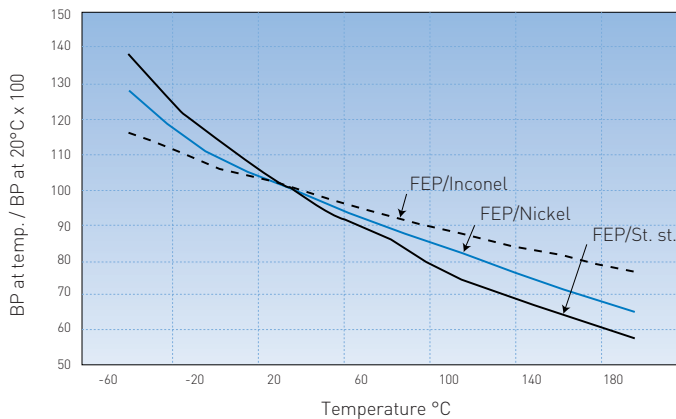

TEMPERATURE EFFECT FOR CONVENTIONAL TYPE DISCS

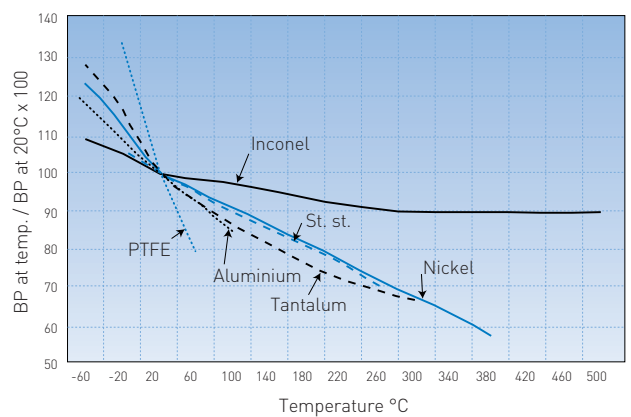

MARSTON BURSTING DISCS

REVERSE PRESSURE SUPPORTS

VACUUM/REVERSE PRESSURE SUPPORTS

Many simple conventional discs and most composite slotted bursting discs are unable to withstand vacuum conditions without assistance.

To allow them to be used for duties where vacuum is a possibility, even if only whilst equipment is being cleaned, a vacuum support can be fitted. Usually, this takes the form of a multi-petal design opening type support which, when the disc bursts, opens up to provide a large flow area.

The vacuum support is fixed permanently to the bursting disc to ensure correct fitting. Therefore, a new support does have to be supplied and fitted with each bursting disc.

When calculating the disc size required, the free area through the support must always be considered.



Opening type vacuum supports

In some applications, reverse pressures may exist greater than atmospheric pressure. Often an opening type support alone will be sufficient. However, sometimes an additional auxiliary support is required. This is designed to aid the opening support, whilst still maintaining a large free flow area. This type of support is often used in double disc assemblies, where a secondary disc is used to prevent an often variable reverse pressure from affecting the performance of the primary disc. This is common when several bursting discs vent into a common line or flare stack. Generally, this type of support is re-useable, with only the opening support needing to be replaced.



Auxiliary support

Some discs, particularly graphite, use a permanent or non-opening type vacuum support. Usually these supports are not attached to the disc but fit immediately upstream of the bursting disc, sometimes in a recess provided within the holder.

These supports follow the form of the disc, whether it be flat or domed, and have holes through which the product flows when the disc bursts. These supports are considered to be re-useable and therefore only one is required for each position.



Non-opening supports

More consideration must be given to the flow area for these supports as a typical free area through a permanent support is around 60%.

Generally, reverse buckling discs do not require any additional support to withstand vacuum or reverse pressure.

MARSTON BURSTING DISCS

HOLDERS

HOLDERS

The bursting disc holder can have a significant effect on the performance of a bursting disc. The holder provides an accurate location, sealing face, vent bore size and form. Generally, holders will be manufactured from stainless steel, though other materials can be supplied when required. Holders are normally non-torque sensitive.

Marston holders are designed specifically for each disc type and to fit the particular application. Usually the holder will be an insert type; one that fits within the flange bolt circle. This provides an easier method of fitting replacement bursting discs since fewer flange bolts need to be removed. Full face holders with flange bolt holes can be supplied if required.

Usually holders consist of two annular rings that provide a flat sealing flange for the bursting disc. Consequently, the performance of the disc should be unaffected by excessive flange bolt loading (certain graphite assemblies require close control of the flange bolt torque). Most holders are supplied with assembly screws. These can be simply to hold the assembly together whilst fitting onto the plant, or, for pre-torque type holders, they are tightened to pre-set values to ensure an adequate joint is achieved between the disc and holder before installing onto the plant.

For sizes up to 250 mm bore, the holder usually will provide dome protection. Larger sizes often are supplied without dome protection and, where conditions allow, simple clamp rings may be acceptable. Where the bursting disc dome is not protected, extreme care must be taken when fitting to prevent damage.

For large assemblies, where the holder weight exceeds 25 kg, or where it is considered beneficial for handling purposes, provision will be made for suitable lifting attachments.

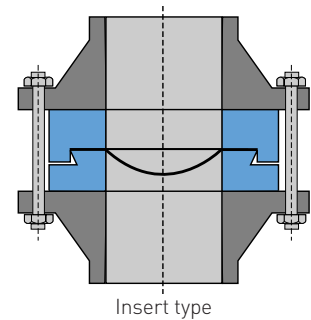

Insert type

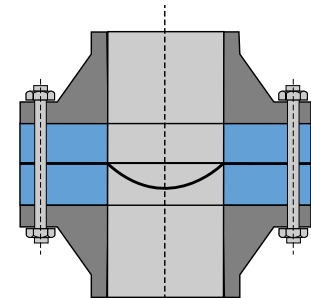

Full face type

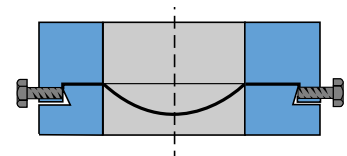

Pre-assembled holder

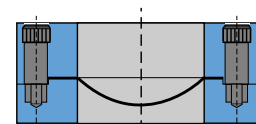

Pre-torqued holder

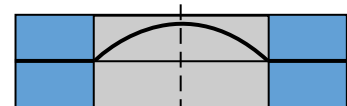

Protected dome

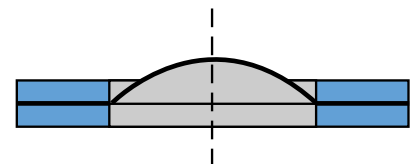

Unprotected dome

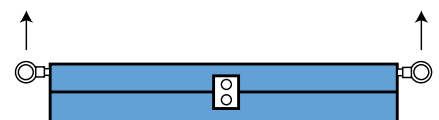

MARSTON BURSTING DISCS

HOLDERS

SCREWED, WELDED AND ADAPTOR TYPE ASSEMBLIES

TYPE

AM

A screwed adaptor as illustrated with male connection threads. Special designs are often manufactured to customer's requirements. The standard pressure range is up to 700 barg but higher pressures can be made to special order.

TYPICAL CONNECTION

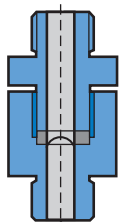

1/4" to 1 1/4" NPT / BSP

Where simple flanged joints are not practical, alternative designs are available. A wide variety of screwed assemblies and fully welded units can be supplied, to satisfy the most arduous of requirements. These allow for screwing a disc holder unit into the main body of the pressurized vessel or for fitting directly into pipelines. Where it is practical, the discs may be scored so that they petal open. Various types are illustrated, with special designs prepared as required.

AF

A screwed adaptor as illustrated with female connection threads. Special designs are often manufactured to customer's requirements. The standard pressure range is up to 700 barg but higher pressures can be made to special order.

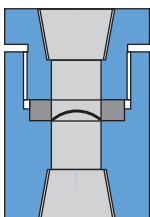

1/4" to 1 1/4" NPT / BSP

LR

A lens ring style bursting disc. This is another method of mounting a disc in high pressure pipework. It provides a leaktight seal at pressures up to 700 barg.

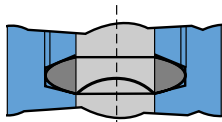

3/8" to 2" NB
8 to 50 mm NB

MARSTON BURSTING DISCS

HOLDERS

OPTIONAL FEATURES

Pressure tappings

Tappings for monitoring equipment can be incorporated in the vent-side of the holder, or in the pressure-side if required. Usually any thread form and size is possible but in some cases this may require an increase in holder dimensions.

Corrosion protection

For corrosive environments, holders manufactured from resistant materials may prove costly. One possible alternative is the glass filled-PTFE insert that also provides a non-stick surface. For extreme conditions a resistant metal liner such as nickel or tantalum may be suitable.

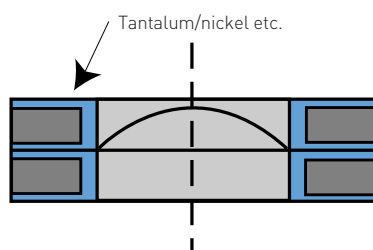
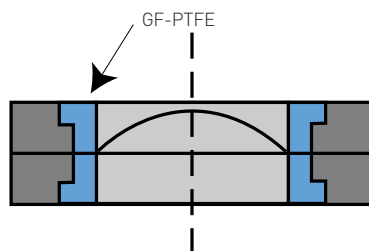

Steam heating

Where the duty may be prone to polymerisation the holder can be heated. This can be achieved by introducing a chamber around the holder body and passing either hot water or steam through to prevent the product from cooling and solidifying.

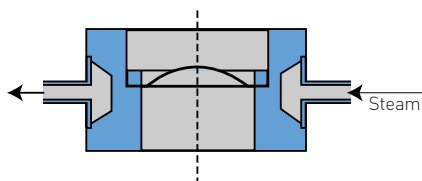

High pressure

When the bursting pressures exceed the limits for standard holder designs to retain the disc satisfactorily, alternative designs are available. Wedge type holders can be supplied on request but their performance can be affected by possible misalignment or incorrect torque of the plant flange bolts. So, for high pressures, the use of discs with welded edge rings that fit into a simple recessed holder is recommended.

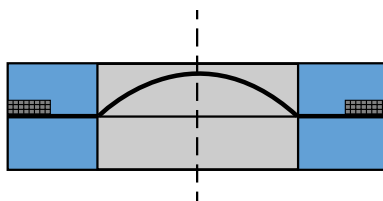

MARSTON BURSTING DISCS

HOLDERS

TABLE OF OUTSIDE DIAMETERS

Capsule holders, to fit within the ring of flange bolts.

Flange rating		Holder outside diameter for nominal bores (mm)														
ANSI	PN	25	40	50	65	80	100	150	200	250	300	350	400	450	500	600
150		66	85	104	123	136	174	222	279	339	409	450	514	549	606	717
	10	73	94	109	129	144	164	220	275	330	380	440	491	-	596	698
300		73	95	111	130	149	181	251	308	362	422					
	16	73	94	109	129	144	164	220	275	331						
	25	73	94	109	129	144	170	226	286	343						
600		73	95	111	130	149	197	266								
	40	73	94	109	129	144	170	226								
900		79	98	143	165	168	205									
	63	84	105	115	140	150	176									
1500		79	98	143	165	174										
	100	84	105	121	146	156										

FLANGE SEALING

Usually, bursting disc holders can be provided to satisfy the requirements of any type of flange sealing arrangement. The diagrams below illustrate typical examples. Flange joints (i.e. those between the holder and the mating flanges) normally will be provided by the customer. Gaskets will be supplied for bursting discs that are designed to be fitted directly between flanges, such as the Monobloc graphite disc.

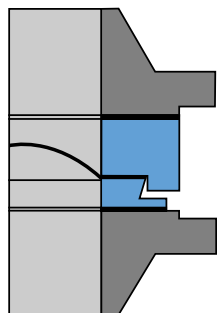

Flat gasket joint

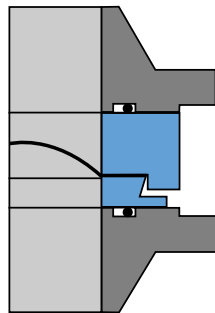

'O' ring joint for minimum leakage

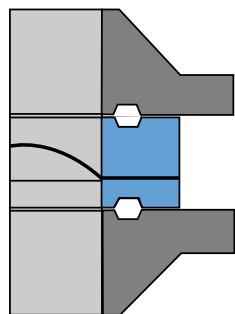

Ring type joint for high pressure/temperature

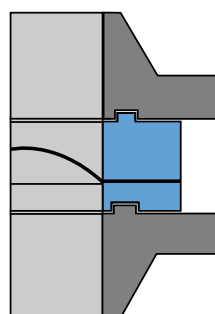

Tongue and groove

LOCATION OF HOLDER BETWEEN FLANGES

To ensure that the bursting disc holder is installed concentrically, each Marston bursting disc holder has an outside diameter manufactured specifically to suit its corresponding flange.

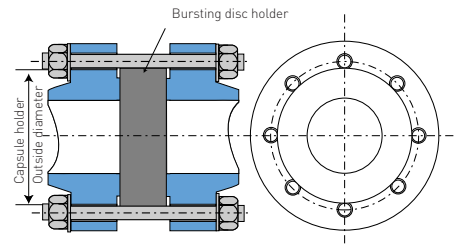

Holder heights are available on request.

MARSTON BURSTING DISCS

ACCESSORIES

BURST DISC INDICATORS

Once a bursting disc has ruptured, it is often beneficial to shut down relevant plant equipment as quickly as possible. One common method of achieving this is to fit a burst disc indicator. This is a simple circuit, usually fitted downstream of the bursting disc, which is broken upon disc rupture. Usually the signal is received in the plant control room, instigating the shutdown of the relevant equipment.

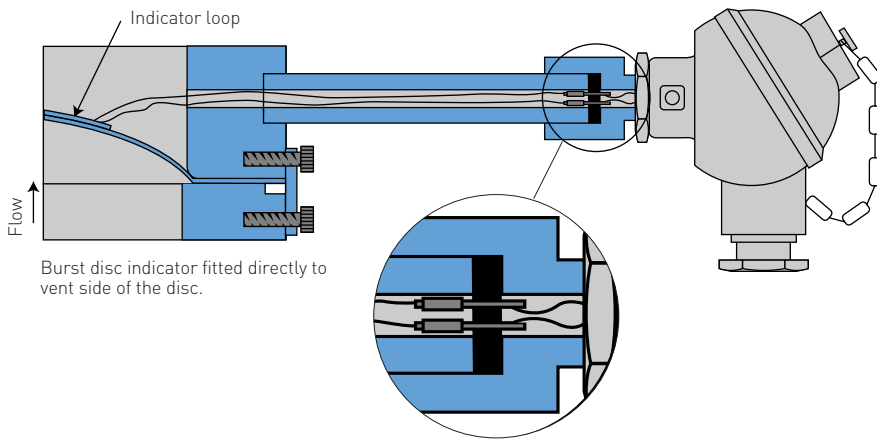

There are two basic types of Marston burst disc indicator, one which is fitted directly to the disc and one which is fitted between the holder and the downstream pipe flange. This can be fitted to existing disc assemblies or safety relief valves.

All Marston burst disc indicators have been approved by BASEEFA to EEx ia IIC T6 (Tamb = 75°C); i.e. they do not induce or release sufficient electrical energy when they function to cause an explosion even in the most hazardous environment, Zone 0.

The system requires a 100 mA maximum supply feed from an appropriate isolator barrier.

Note: when a Zener barrier is used, the holder must be earthed to inhibit high circulating currents.

When the indicator is fitted directly to the bursting disc, it is normal to run the electrical lead wires through a suitable connection head. For the remote indicator, the lead wires are routed through the gasket to an armoured, shielded, supply lead.

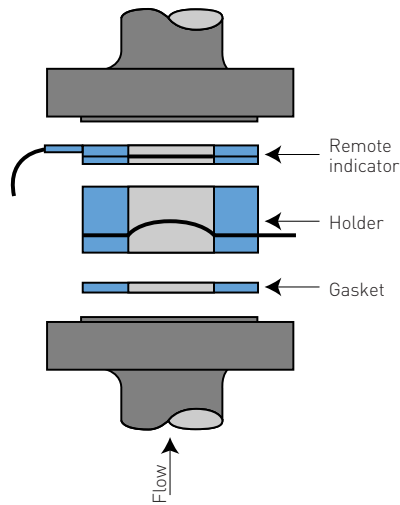

Burst disc indicator for remote fitting between holder and vent side flange.

Burst disc indicators are components which have been considered NOT to require EMC testing on their own. It is the user's responsibility to ensure compliance with the EMC directive in relation to their particular system.

MARSTON BURSTING DISCS

ACCESSORIES

EXCESS FLOW VALVES

Excess flow valves (EFV) may be fitted to prevent back pressure developing between a bursting disc and, for example, a safety relief valve during normal plant operation. The excess flow valves should be fitted in a horizontal mode. In the event of the disc rupturing, the excess flow valve will seal the vent system under the influence of the pressure pulse.

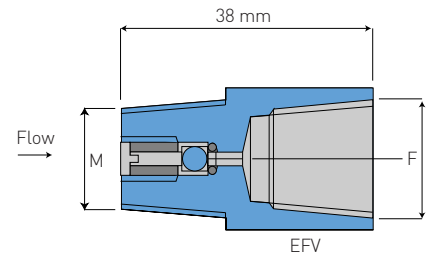

Standard dimensions (BSP or NPT)			
M	1/4"	3/8"	1/2"
F	1/8"	1/4"	3/8"

Pressure gauges

Normally pressure gauges are supplied by the user, although they can be supplied on request.

Jack screws

Jack-screws may be required to help users to separate the bursting disc holder from the system flanges during overhaul or following an incident. Normally these are incorporated into pipe-flange drillings, although suitable screws can be supplied if requested.

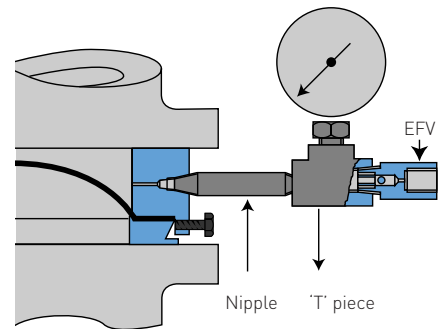

'J' bolt

It is important that bursting disc assemblies are mounted in the correct orientation relative to the flow direction. Although the holder is stamped with a flow arrow and the vent-side is also shown on the holder and disc labels, often it is a requirement that the installation is 'foolproofed'. One such example is a 'J' bolt (as shown) which is welded to the holder and locates in a corresponding hole in one of the flanges. Other methods also are available.

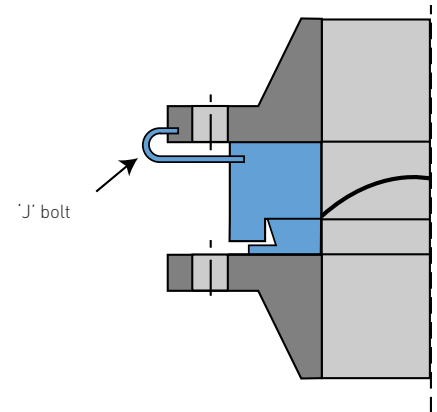

MARSTON BURSTING DISCS

VALVE PROTECTION / LEAK TIGHTNESS

THE PROTECTION OF SAFETY VALVES*

Safety valve service life can be prolonged by using a bursting disc in series with the valve. The disc can be designed to be fitted at the inlet or at the outlet of the safety valve.

Bursting discs are:

1. Virtually leak free.
2. Capable of preventing the process media attacking the internal parts of the safety valve, either by providing corrosion resistance or a physical barrier.
3. Suitable for protecting the vent side of the safety valve from the ingress of moisture and associated debris from the vent system.

Bursting discs are selected with a bore size suitable for the appropriate inlet or vent flange of the safety valve.

The free vent area of the bursting disc used on the inlet side of the safety valve is always substantially greater than that of the valve. A number of international standards are available to allow the calculation of suitable bursting disc sizes.

In all cases an excess flow valve is advised to prevent any pressure build up between the bursting disc and the safety valve.

* **Safety valves** may also be referred to as **relief valves** or **safety relief valves**. Such valves are characterized by their ability to relieve excessive pressures at a pre-determined level and to re-seal once that pressure has been reduced to an acceptable, safe level. Such devices provide re-closing pressure relief and limit the quantity of product actually released.

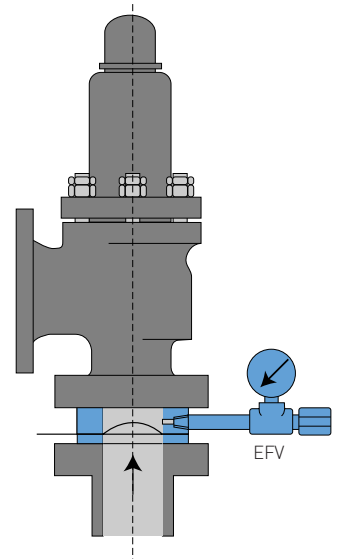

FUGITIVE EMISSIONS: LEAK TIGHTNESS ACROSS DISC SEALING FLANGE

FEATURES

Metal to metal joint

LEAK TIGHTNESS MBAR.L/S

1×10^{-4}

Gasket fitted to process side:

GARFITE (Graphite-based)

1×10^{-4}

AFM 34 (Asbestos free)

1×10^{-4}

AFM 30 (Asbestos free)

1×10^{-4}

PTFE

1×10^{-4}

GYLON BLUE (PTFE)

1×10^{-5}

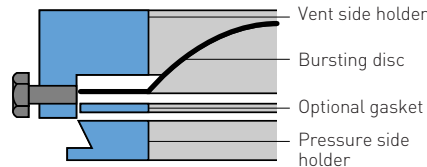

'O' rings incorporated:

PTFE

1×10^{-6}

FKM

1×10^{-6}

Silver-coated metal

1×10^{-8}

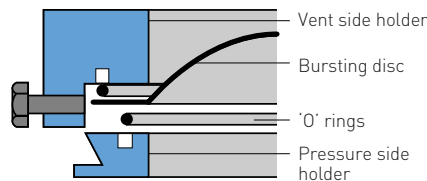

Disc welded to holder

ZERO

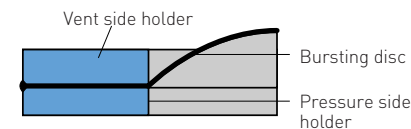

Type MN: flat gasket:

Garfite (Graphite based)

1×10^{-3}

AFM 34 (Asbestos free)

1×10^{-3}

PTFE / GYLON

1×10^{-4}

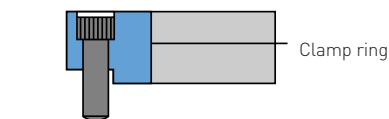

Type M0: 'O' rings:

PTFE

1×10^{-4}

FKM

1×10^{-6}

Silver coated metal

1×10^{-8}

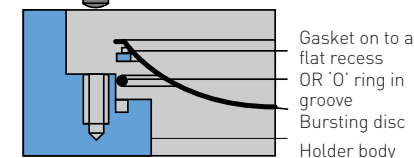

MARSTON BURSTING DISCS

SELECTION

Forward acting bursting discs

NTG/NRG

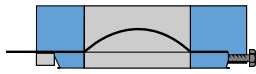

Applications

1, 2, 3, 4, 5, 6, 7, 8

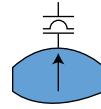

1 Simple application where a disc is the primary safety device on a pressurized system

CS

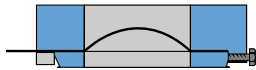

1, 2, 3, 4, 5, 6, 7, 8

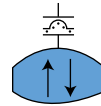

2 Simple application where a disc is the primary safety device. Negative pressure may require a reverse pressure support.

Reverse buckling bursting discs

MN/MO

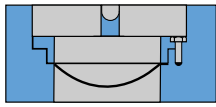

1, 2, 3, 4, 5, 6, 7, 8

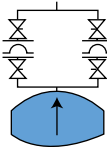

3 Two discs mounted in parallel with interlocked valves enabling rapid changeover from a ruptured disc to a second disc.

RBH/RBF

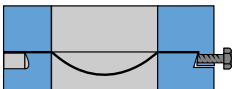

1, 2, 3, 4, 5, 6, 7, 8

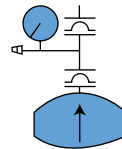

4 Two discs mounted in series. Used where process media is likely to attack a disc material.

LRBH

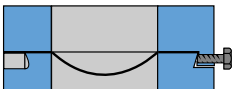

1, 2, 3, 4, 5, 6, 7, 8

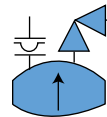

5 A disc used as a secondary safety device. In the event of safety valve failure to vent, the disc provides the ultimate protection.

SRBH

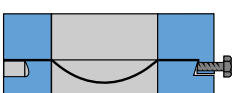

1, 2, 3, 4, 5, 6, 7, 8

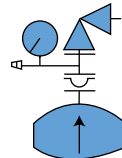

6 A disc used to protect a safety valve. Essential in some corrosive or viscous applications.

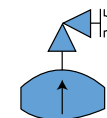

7 Where corrosion could attack the ventside of a safety valve, discs may be employed as a protection.

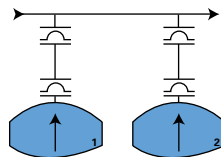

8 Two discs mounted in series. Used where multiple relief streams vent into a common manifold.

Neither Emerson, Emerson Automation Solutions, nor any of their affiliated entities assumes responsibility for the selection, use or maintenance of any product. Responsibility for proper selection, use, and maintenance of any product remains solely with the purchaser and end user.

Marston is a mark owned by one of the companies in the Emerson Automation Solutions business unit of Emerson Electric Co. Emerson Automation Solutions, Emerson and the Emerson logo are trademarks and service marks of Emerson Electric Co. All other marks are the property of their respective owners.

The contents of this publication are presented for informational purposes only, and while every effort has been made to ensure their accuracy, they are not to be construed as warranties or guarantees, express or implied, regarding the products or services described herein or their use or applicability. All sales are governed by our terms and conditions, which are available upon request. We reserve the right to modify or improve the designs or specifications of such products at any time without notice.